

A NEW METHODOLOGY FOR AUDIO FREQUENCY
POWER AMPLIFIER TESTING BASED ON PSYCHOACOUSTIC
DATA THAT BETTER CORRELATES WITH SOUND QUALITY

BY

Daniel H. Cheever

B.S.E.E. 1989, University of New Hampshire

THESIS

Submitted to the University of New Hampshire
in partial fulfillment of the Requirements for the Degree of

Master of Science

In

Electrical and Computer Engineering

December 2001

This Thesis has been examined and approved.

Thesis Director, Prof. John R. Lacourse,
Chairman of the Electrical and Computer
Engineering Department

K. Sivaprasad, Professor, Electrical and
Computer Engineering Department

L.G. Kraft, Professor, Electrical and Computer
Engineering Department

Date

DEDICATION

I dedicate this thesis to my wife Sylvia, whom has given me the conviction and support to succeed in whatever I attempt. I must emphasize that not all I have attempted has been completed, though. My audio hobby has resulted in a basement full of electronic scrap from many eras and quite homely hi-fi equipment in living areas in various states of repair. I recall her asking about a certain MC head amp “why do you need a pre-amp for your pre-amp”. Moreover she has had to put up with my near religious following of rather nebulous aspects of sound reproduction.

Indeed I had promised her at the initiation of my graduate work in 1993 that I would be completed before our first born. Alexander is now 5 and Sophia 3. I thank her for her patience while I “putzed around” in the basement bent on building better and better amplifiers. I thank her for her help typing the thesis and all her efforts towards revising some sections to be more readable and somewhat more earthbound.

DEDICATION.....	iii
LIST OF TABLES.....	vi
LIST OF FIGURES.....	vii
ABSTRACT.....	ix
CHAPTER	PAGE
INTRODUCTION.....	1
I. The lack of correlation between objective measurements and subjective sound quality- history and examples.....	2
1. Introduction.....	2
2. The history of audio measurements	5
3. Examples of standard measurements	21
4. Conclusion- a call for a new methodology.....	31
II. A new audio test philosophy.....	34
1. Harmonic consonance.....	35
2. The sound pressure level dependence of the aural harmonic envelope.....	41
3. Intermodulation distortion.....	49
4. Pre-transient noise bursts.....	51
5. The fallacy of negative feedback as a cure-all.....	52
III. Measurement protocol of the Total Aural Disconsonance figure of merit.....	64
1. Device measurements.....	64
2. A measurement protocol for the Total Aural Disconsonance figure of merit.....	68
IV. Conclusion.....	72
Bibliography.....	76

LIST OF TABLES

Table 1-1	Comparison between distortion mechanism and measurement type	Pg. 18
Table 2-1	Spreadsheet based T.A.D calculations for two amplifiers.	Pg 47
Table 2-2	Distortion components versus feedback level for a square law dominated gain device	Pgs. 56-57
Table 2-3	Distortion components versus feedback level for an exponentially non-linear gain device.	Pg. 61
Table 3-1	Aural Harmonics from Eq. 2-1 over a reduced S.P.L range.	Pg. 58

Fig. 1-1	Poor standard test measurements for an excellent sounding amplifier	Pg. 3
Fig. 1-2	Standard measurements for a modern amplifier with average sound quality	Pg. 4
Fig. 1-3	Correlation between different harmonic order weighting and subjective sound quality	Pg. 9
Fig. 1-4	Overload characteristics “hidden” inside the feedback loop	Pg. 12
Fig. 1-5	Disagreement between clipping distortion measurements between the common average reading meter and peak harmonic percentage.	Pg. 13
Fig. 1-6	Comparison of Dynamic I.M. with common I.M.D	Pg. 17
Fig. 1-7	FASTtest Methodology and spectrum	Pg. 17
Fig. 1-8	Performance comparison between FASTtest and other methods.	Pg. 20
Fig. 1-9	Hafler DH500 audio power amplifier schematic, one channel shown.	Pg. 21
Fig. 1-10	Block diagram of test set-up.	Pg. 23
Fig 1-11	DH500 distortion components and T.H.D at 1 kHz, 32W.	Pg. 24
Fig. 1-12	DH500 distortion components and T.H.D at 15 kHz, 23W	Pg. 24
Fig. 1-13	DH500 intermodulation distortion, 4kHz:15kHz at 4W.	Pg. 25
Fig. 1-14	DH500 D.I.M, 3.18kHz:15kHz, 10W	Pg. 26
Fig. 1-15	Schematic of the type 45 triode tube based Single-ended audio amplifier	Pg. 28
Fig. 1-16	Type 45 S.E. amplifier frequency response	Pg. 28
Fig. 1-17	Type 45 S.E. amplifier 1kHz harmonic distortion components at 0.4W	Pg. 29
Fig. 1-18	Type 45 S.E. amplifier 200Hz-7kHz IM	Pg. 29
Fig. 1-19	Type 45 S.E. amplifier 14kHz:15kHz IM	Pg. 30
Fig. 1-20	Type 45 S.E. amplifier D.I.M	Pg. 30
Fig. 2.1	Ear self-generated harmonics, frequency versus level.	Pg. 36
Fig. 2-2	Ear self-generated harmonics, level versus sound pressure level	Pg. 37
Fig. 2-3	Ear self-generated harmonics, level versus sound pressure level	Pg. 37
Fig. 2-4	Subset of Fig. 2-3 with reduced SPL range for clarity	Pg. 38
Fig. 2-5	Pitch change necessary to distinguish a second tone	Pg. 39
Fig. 2-6	Tone masking research showing aural harmonics	Pg. 40
Fig. 2-7	Showing fit of Eq. 2.1 versus Olson aural harmonic test data.	Pg. 42
Fig. 2-8	1.5W Type 45 triode feedback-less single-ended amplifier at 0.32 W rms.	Pg. 46
Fig. 2-9	10W Bi-polar transistor feedback amplifier at 0.72 W rms.	Pg. 46

Fig. 2-10	Two amplifiers distortion harmonics versus aural harmonics.	Pg. 47
Fig 2-11	D.I.M. measurement example for a non-feedback amplifier	Pg. 50
Fig. 2-12	D.I.M. measurement example for a feedback amplifier	Pg. 50
Fig. 2-13	Negative feedback block diagram	Pg. 52
Fig. 2-14	Transconductance graph for a power field effect transistor	Pg. 55
Fig. 2-15	Calculated distortion versus feedback level using the equations in table 2-2.	Pg. 58
Fig. 2-16	Calculated distortion versus feedback level using the equations in table 2-3.	Pg. 62
Fig. 3-1	Schematic of the single-ended F.E.T. output stage.	Pg. 64
Fig. 3-2	Calculated and measured distortion versus feedback level, FET SE output stage.	Pg. 66
Fig. 3-3	Subset of the DH500 amplifier schematic showing the point where feedback is removed and a signal injected.	Pg. 69
Fig. 3-4	DH500 Open-loop harmonic distortion at 0.4W	Pg. 70
Fig. 3-5	Output level variation of the type 45 SE amplifier when loaded with a loudspeaker	Pg. 74

A NEW METHODOLOGY FOR AUDIO FREQUENCY
POWER AMPLIFIER TESTING BASED ON PSYCHO-ACOUSTIC
DATA THAT BETTER CORRELATES WITH SOUND QUALITY.

By

Daniel H. Cheever

University of New Hampshire, December 2001

There exists general agreement that the commonly accepted test and measurement protocols for audio frequency power amplifiers fail to correlate with the subjectively assessed devices sound quality. A review of the history of audio testing was undertaken to reveal if prior art has produced tests that better correlate with sound quality. A universal concept emerged, one that calls for stronger weight of the higher order, more aurally discordant harmonic distortion products, over the low order, more benign harmonics. Separately a study of the psychoacoustics of the ear resulted in a mathematical derivation of the ears intrinsic aural distortion. The two are combined and offer a methodology for weighing the harmonics based on a dimensionless figure of merit that quantifies the amplifier's harmonic distortion envelopes departure from the ears aural masking, named Total Aural Disconsonance or T.A.D. It is shown both analytically and through actual device measurements that the application of negative feedback, regardless of level, results in poorer T.A.D. figures. Two amplifiers of opposing standard measurement results are fully tested and subjectively analyzed and results show that the T.A.D. method outperforms classic T.H.D and I.M. for characterizing amplifier quality.

INTRODUCTION

Humans respond emotionally to complex musical messages that contain no real survival value. This phenomenon indicates that the human brain is instinctively motivated to entertain itself with sound processing primary sense operations. This is a cross cultural phenomenon that most likely results from an inborn drive to learn, at an early age, the sophisticated auditory analysis required for speech perception. Aesthetic appreciation of music may be due to man's need to exercise their neural network.

In this era we have access to musical reproduction equipment in a range of qualities. High fidelity equipment strives to reproduce the original musical event. Perfect fidelity is perfect reproduction of the signal. A modern music reproduction system relies on recorded music being reproduced via sound transducers. Microphones convert the instantaneous acoustic pressure of the musical performance into electrical signals. These signals are amplified and recorded onto media. The playback devices output is amplified by an audio power amplifier which drives the loudspeakers. On all the elements in the chain, except for the power amplifier, there is general agreement between the current standardized fidelity objective specifications and the sound quality. This thesis is an investigation of the hypothesis that the current accepted measurements that quantify fidelity of an amplifier fail to correlate well with subjective sound quality. Proposed is a more accurate set of measurement protocols.

CHAPTER 1

THE LACK OF CORRELATION BETWEEN OBJECTIVE MEASUREMENTS AND SUBJECTIVE SOUND QUALITY- HISTORY AND EXAMPLES.

1. Introduction

In September on 1995, Stereophile, an established highly respected hi-fi magazine, ran a review of the Cary 300SEI, the first mainstream review of a single ended amplifier¹. In this design, a single output device is tasked with producing both polarities of the signal swing and had zero negative feedback. Robert Hartley, one of the senior reviewers, states:

The 300SEI communicated music in a way I'd never experienced before. There was an immediacy and palpability to the sound that was breathtaking- a musical immediacy the riveted my attention to the music. It reproduced massed violins with beauty unmatched by any electronics I've had in my system. It excelled in the most important areas: Harmonic rightness, total lack of grain, astonishing transparency, lifelike sound staging, and a palpability that made the instruments and voices exist in the room.^[2]

The article then follows with the standard lab bench test results such as harmonic distortion spectra, frequency flatness, etc. Every specification; output power, frequency

¹ Stereophile Magazine^[1]. September 1995 pp.141-149.

response, output impedance, harmonic distortion, and intermodulation distortion, were the poorest results I have noted published.

This amplifier measured so poorly as to be a joke...contrary to what we consider good technical performance. I'm convinced the 300SEI doesn't harm the signal in ways push-pull amplifiers do, and that what the 300SEI does right is beyond the ability of today's traditional measurements to quantify. I have become convinced single ended tube amplifiers sound fabulous *in spite of* their distortion, *not because of* it. [3]

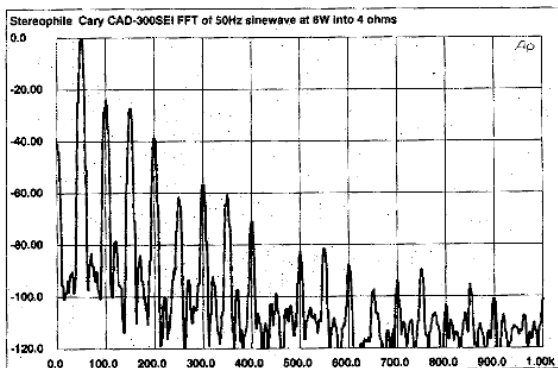

Fig.8 Cary CAD-300SEI, spectrum of 50Hz sine wave, DC-1kHz, at 6W into 4 ohms (linear frequency scale). Note that the second harmonic at 100Hz is the highest in level, at -26dB (5%)!

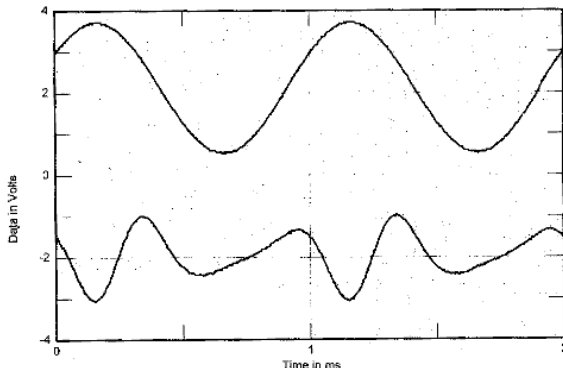

Fig.9 Cary CAD-300SEI, 1kHz waveform at 1W into 8 ohms (top); distortion and noise waveform with fundamental notched out (bottom).

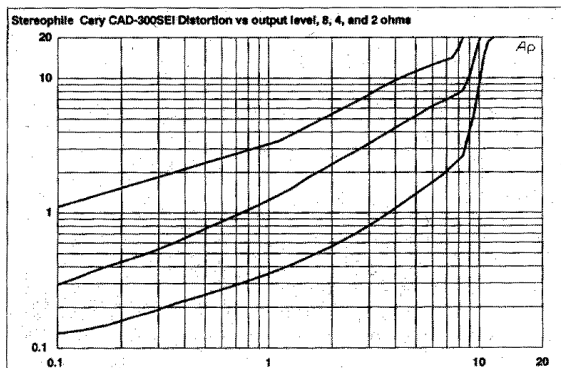

Fig.10 Cary CAD-300SEI, distortion (%) vs output power into (from bottom to top at 10W): 8 ohms, 4 ohms, and 2 ohms.

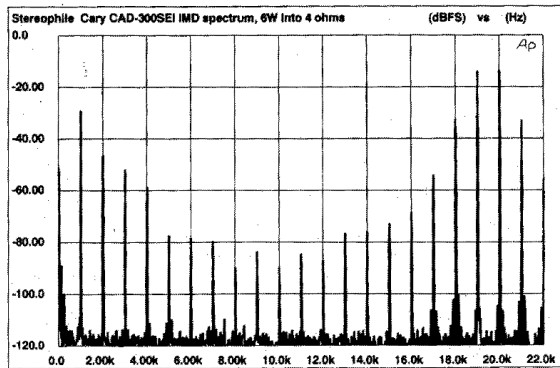

Fig.11 Cary CAD-300SEI, HF intermodulation spectrum, DC-22kHz, 19+20kHz at 6W into 4 ohms (linear frequency scale).

Fig. 1-1 [4] Poor standard test measurements for an excellent sounding amplifier

Figure 1-1 speaks for the obvious concern that the objective measurements of this amplifier are very poor. Compare the results in Fig. 1-1 with the following Fig. 1-2 from

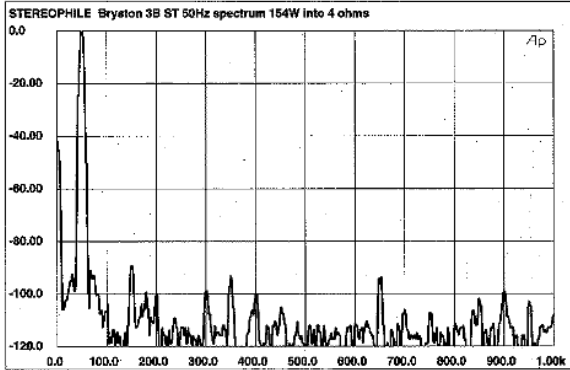

Fig.12 Bryston 3B-ST, spectrum of 50Hz sine wave, DC-1kHz, at 154W into 4 ohms (linear frequency scale).

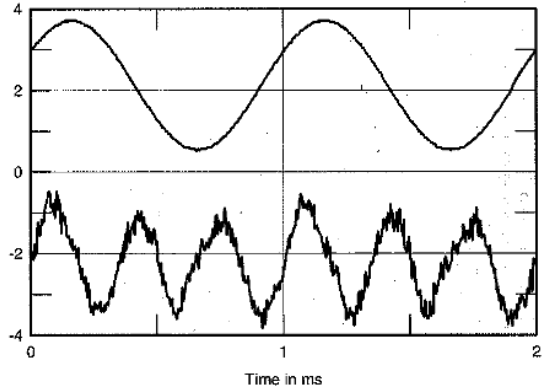

Fig.11 Bryston 3B-ST, 1kHz waveform at 25W into 2 ohms (top); distortion and noise waveform with fundamental notched out (bottom, not to scale).

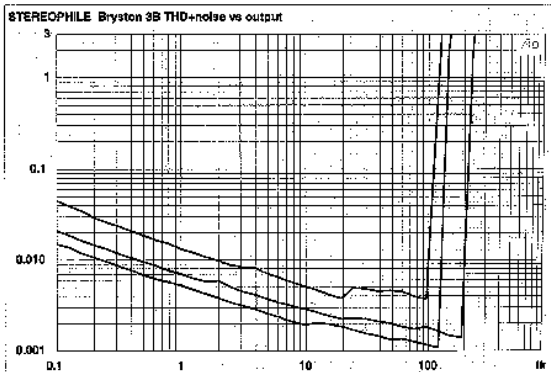

Fig.16 Bryston 3B-ST, distortion (%) vs output power into (from bottom to top at 100W): 8 ohms, 4 ohms, and 2 ohms.

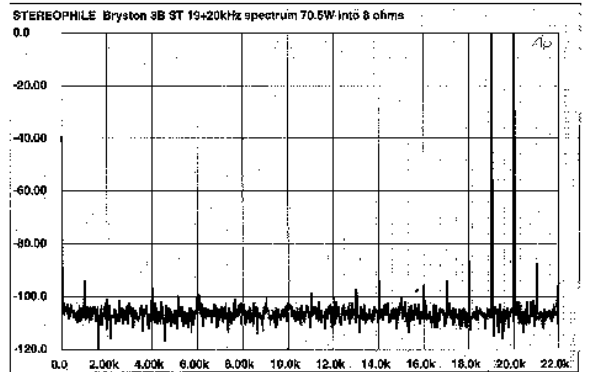

Fig.14 Bryston 3B-ST, HF intermodulation spectrum, DC-22kHz, 19+20kHz at 70.5W into 8 ohms (linear frequency scale).

Fig. 1-2 ^[6] *Standard measurements for a modern amplifier with average sound quality*

a renowned solid-state audio power amplifier, the 120 Watt per channel Bryston 3B-ST. Note the harmonic distortion is nearly 100dB down, over 7000 times “better” than the Cary CAD-300SEI. Intermodulation distortion 85dB down, or 500 times “better”. Distortion only 0.002% at 100W compared to over 2% at 8W for the Cary CAD-300SEI. Yet, the review of the Bryston 3B-ST resulted in comments on lack of smoothness and high frequency transparency, and of other amplifiers offering better imaging and transparency. This same language was used in the review of the Cary CAD-300SEI, and precisely in the areas where the CAD-300SEI excelled. These trade magazines are a common way the buying public informs itself on sound reproduction equipment buying decisions. Indeed there exist F.T.C.² regulations on the publishing of common amplifier measurement results. The purpose of this thesis is to investigate if there are measurement parameters that have been overlooked, avoided, or conveniently been ignored in the reproduction of quality sound for human enjoyment

2. The History of Audio Measurements.

Since the review of the Cary CAD-300SEI almost no issue of an audio publication³ has been without a glorious review of a simple topology amplifier followed by atrocious technical measurements. An in depth historical study was undertaken to

² Federal Trade Commission. For example the text on the shipping carton of an amplifier “80 watts per channel at 0.08% THD over 20-20kHz” requires the following of the F.T.C. test guidelines.

³ I have a large private collection of audio magazines. Including Stereophile 1988 – present, Stereo Review 1982-1987, Listener 1991- present, Audio 1982 – 1989.

investigate possible existing but not popularized testing methodologies that may correlate better with audio quality perception.

In 1925 Edward Kellogg, the co-inventor of the moving coil loud speaker, wrote a landmark paper “The design of non-distorting power amplifiers”^[6]. It suggests that 5% distortion is the permissible limit for audio amplifiers. He indicated that this much distortion can be tolerated only when the curvature of the transfer characteristic is “uniform” rather than “turning abruptly”. This is the first implication that amplifier quality is diminished if the distortion products are not of low order. Kellogg and others at this time measured distortion by inserting a notch filter at the fundamental and reading the value of any remaining harmonics and noise on an AC voltmeter. Today this is the most common specification used called total harmonic distortion (T.H.D.⁴). The triode, the only amplifying device available at that time, when used correctly, keeps the harmonic order of the distortion to the first two harmonics thus there is good correlation with sound quality in quoting simple percentage figures. The commercial focus since then seems to be on reducing the commonly measurable aspects of harmonic distortion without regard to the non-linearity of amplification devices.

The origin of the era of correlating amplifier quality with distortion measurements begins with a statement by W.T. Cocking in 1934^[7]. He suggested that

⁴ Commonly T.H.D. or Total Harmonic Distortion, is actually the Root Mean Square sum of the harmonics in the audible frequency range of a mid-band test signal. The individual harmonic powers are squared, added together, and the square root results in the T.H.D. figure.

5% distortion was too high for quality amplification. Cocking compared triodes to the newly released pentodes and found triodes preferable due to the less objectionable distortion products and its ability to better damp the loudspeaker. That same year Harold S. Black published “Stabilized Feedback Amplifiers”^[8]. Black conceptualized negative feedback. He found that by returning to the input an inverted portion of the output signal distortion was reduced by the same ratio as gain. Negative feedback was now without exception implemented in all power amplifier designs. Quickly class AB⁵ push-pull design with more efficient pentodes became more popular with higher power output and lower cost than the triode based circuits. Three very successful examples are the 1945 Quad^[9] (the Williamson), the 1949 McIntosh, 50W-1^[10] and the 1951 Hafler Ultra-Linear circuit^[11]. All of these designs added circuit and output transformer complexity to allow for use of the more non-linear pentodes. It is my opinion that the emerging trend was to convince the consumers blind faith in specifications - maximize power and minimize T.H.D.

Two papers in this period called to question the now standard T.H.D. specification. The first was the 1937 Radio Manufacturers Association⁶ “Specification for amplifiers with two testing and expressing overall performance of radio broadcast

⁵ Class AB signifies a push-pull operating mode in where either device does not linearly amplify the entire waveform. More plainly stated, the opposing polarities of the waveform are handed off between two unipolar devices with usually less than 5% overlap. The less overlap the more crossover distortion due to the (all) devices transconductance being less linear near cut-off. More feedback thus is required to attempt eliminate the crossover distortion.

⁶ U.K.

receivers”^[12]. According to this procedure, when performing the sum of the individual harmonics, the amplitude of the n^{th} harmonic is multiplied by $n/2$. The contribution of second harmonic is thus unchanged but higher harmonics are more and more severely weighted due to the general agreement that higher order harmonics are more offensive to the ear. No reference is cited on the sex, age, or the number of listeners. The state of the art at this time includes push-pull amplifiers with feedback applied with varying levels of subjective success. The originator of the RMA specification later writes that the audibility threshold of the sample group was 5% second harmonic and 0.1% ninth harmonic. “No simple $x*n^2$ weighing system was really correct.”^[13]

A stronger work was in 1950 by D.E.L. Shorter from the BBC engineering research department “The influence of high order products in non-linear distortion”^[14].

“The commonly accepted figures for the maximum allowable non-linear distortion in reproducing systems are based on work carried out many years ago. Since then, new kinds of apparatus producing forms of distortion not covered by early experiments have come into use, with the result that the subjective assessments of non-linear distortions does not always agree with the assessment based on measurement.”^[14]

He shows the extent of the error that results from the practice of taking the R.M.S. Total Harmonic Distortion as a criterion for subjective quality. He used a test program of solo piano with microphone feeds through a selection of six audio power amplifiers having high levels of negative feedback. The results are shown in Fig. 1-3. The upper two data curves clearly show better agreement between measured distortion and the subjective appraisal than the lower data for the common T.H.D R.M.S. sum of harmonics. The $n/2$

data is the weighting proposed by the R.M.A. The upper data has a more drastic weighting of $n^2/4$ and results in the best agreement between the merit figure and the subjective appraisal as only this $n^2/4$ data correlates correctly between the left most “bad” amplifier and the “perceptible” amplifier. Although unsaid Shorter is inferring that the “new types of equipment” meaning the feedback pentode designs, do not equal the

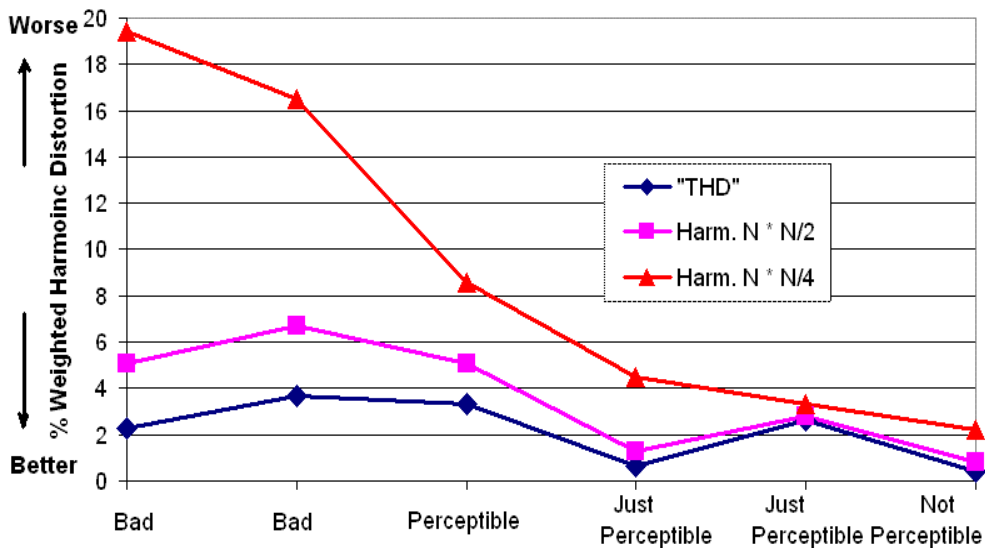

Fig. 1-3. Correlation between different harmonic order weighting and subjective sound quality

subjective quality of equipment free from high order harmonics at a equal or even lower measured distortion using today’s equal weighing method. This paper is also important as it is the first to indicate that amplifiers producing high order harmonics from a single tone will also produce a large number of intermodulation products when several tones are applied. He calls for objective tests to be “so framed that they give the appropriate numerical expression” for intermodulation distortion (I.M.D.). This is also the first

mention of the need to weight the I.M. products in rising order. The modern S.M.P.T.E.⁷ I.M. standard does not weight I.M. products.

Alan Bloch in 1953^[15] mathematically shows that the THD and heterodyne methods need corrected harmonic ratios due to the need to measure out-of-band harmonics but that the new SMPTE intermodulation method^[16] has the additional advantage that the I.M. products are symmetrical around the test frequencies so that the side band in the pass band can be used for test signals near the response extremes. He comments that the mathematical model does not have provision for weighting the higher order terms. The problem is “should the distortion [individual harmonics] component level be determined in order to obtain the best listener index?”.

Norman Crowhearst is the most prolific writer on audio technology in the late 1950’s through the mid 1970’s. He is the lone technical voice in this period campaigning for the concept that simply performing the standard SMPTE IMD or THD test with better and better accuracy is not improving the selectivity of which amplifiers sound better. Amplifiers at this time offer specifications of 0.05% THD and frequency response within 0.1dB to hundreds of kHz. He states “By these figures such amplifiers should sound the same and perfect”^[17]. Crowhearst is first to propose that the very high orders of harmonics due to the proliferation of high levels and multiple loops of feedback create a signal correlated modulating noise floor. Static single sine test signal

⁷ Society for Motion Picture and Television Engineers

performance may not quantify this abrasive effect. In 1957 with “Some Defects in Amplifier Performance not covered by Standard Specifications”^[17] he explains that if the feedback is accomplished in smaller loops⁸ the frequency multiplying effect is further aggravated, as the local loop will result in reduced 2nd and 3rd order harmonics and generate small components of 4th through 9th. Then the global loop takes this and adds further 4th, 6th, and due to the residual of the original 2nd and 3rd now contributes 8th, 12th, 16th, 18th, 24th, 36th, 54th and all the way to 81st! Any phase errors due to reactive loading can accentuate rather than minimize high order harmonics. Crowhearst also shows that the relationship between harmonic and IM measurement is not simple as he shows by experiment. He is also first to bring light to the negative effects of the phase compensating capacitor in the feedback loop, invariable used at this era for ensuring stability in mid to high feedback amplifier designs. He graphically shows how if the output presents a clean square wave response the amplifier relies on a high frequency peak that is critically tuned in order for the feedback to null the ringing. Transient response of the amplifier is marred as the transient performance into a reactive load is worse than if no “trickery” was designed in. Much later work by M. Ojala defines the very high slew rate capability that the driver stages need in order to eliminate this effect. Crowhearst eloquently details feedback amplifier overload characteristics that are hidden

⁸ As remains current practice, mainly because modern semiconductor f_t is higher, so more feedback can be applied locally to individual gain stages to linearize them and maintain stability. Almost all modern amplifiers use both local and global negative feedback.

in standard tests. In reference to Fig. 1-4 he explains that when clipping starts the

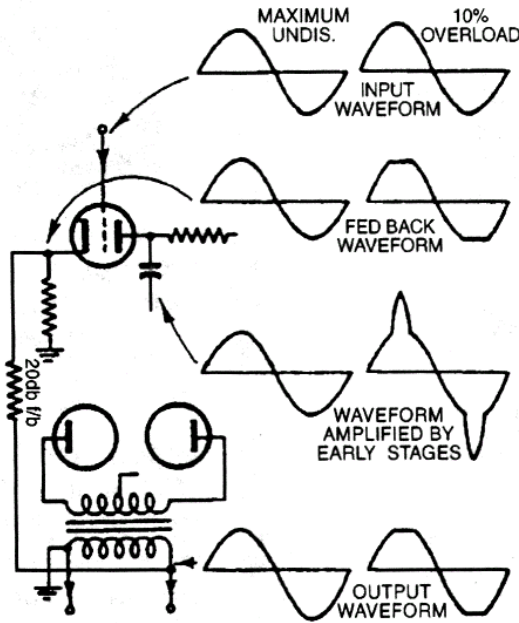

Fig. 1-4. Overload characteristics “hidden” inside the feedback loop.^[17]

voltage is clipped so the waveform amplified by feedback summing node stages develops a sudden peak – the difference between the input and the clipped output. This progressively exaggerates the drive to the output and further increases the clipping. He states

“This explains the familiar complaint that a certain 15 Watt amplifier seems to give more clean output than a certain 60 Watt one...since if the input to the 60 W one is exceeded at all it triggers into this severe distortion condition, distorting not only the peak that caused it but also some of the program that follows”

In later papers such as the 1959 “Feedback – Head Cook and Bottle Washer”^[18]

Crowhearst shows how zero IM distortion can be faked by picking test frequencies that

will null IM. He is also first to point out the miss-use of average reading meter to measure THD at near clipping levels, as is necessary in the common distortion versus

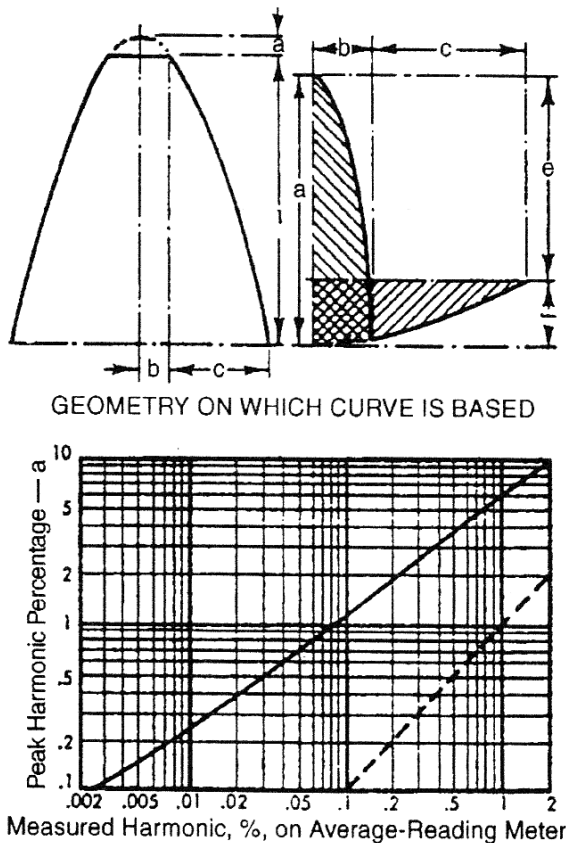

Fig 1-5. *Disagreement between clipping distortion measurements between the common average reading meter and peak harmonic percentage.*

output power graph. This is cleverly shown graphically in Fig 1-5. For example if the input level exceeds the clipping level by 10% measured with an averaging harmonic meter⁹ over a complete cycle, the reading would be only about 2% but the effect is very

⁹ The prevalent instrument of the time. This was essentially a rectified and amplified signal that is integrated by the mechanical meter element. The fundamental is notched out with a steep filter.

audible. Comparison with a similar size amplifier that clips less abruptly (yet earlier) but with low order harmonics¹⁰ would give incorrect conclusions as the distortion will measure five (5) times higher (average) yet still be audibly benign. This peak to average ratio measurement error is even more aggravated for high frequency IMD tests. Crowhears't's conclusions are similar to his predecessors in that distortion analysis be based more on the transfer function linearity rather than on normal harmonic or IMD statements. He further recommends that a standard real-world reactive load be agreed to further test for stability and other distortions. He recommends rating amplifier power at the point where the amplifier returns to linearity after overload, not at the point just before. This is significant as he states that this latch up could account for up to 50% of the audio power^{11, [18]}.

There follows a period until the mid 1970's where there was little new material criticizing conventional amplifier distortion measurements. The transistor was virtually displaced by the vacuum tube in all audio circuits. The new transistor amplifiers offer better specifications, wider frequency response, lower damping factors¹², much

¹⁰ The specmanship race rears its ugly head throughout the history of audio amplification. As higher power density output devices (lower cost per watt) became available they were used, but always they were less linear, so more negative feedback would be required to "out-spec" the older design. The more feedback, the sharper the onset of clipping, and the more abrupt the high-order audible distortions are introduced to the output signal. I show in Chapter 2, Section 5 that the increase of high-order harmonics can be tolerated as long as they follow a certain defined rate of increase.

¹¹ 1960's era commercial pre-transistor audio power amplifiers

¹² A measure of the output impedance of an amplifier. A damping factor of 2 means an output impedance of equal to the loudspeakers nominal but while being a ideal power efficiency match this is considered very poor as common loudspeakers impedance variations will cause frequency response aberrations. $DF = V_{no\ load} / (V_{no\ load} - V_{loaded})$

higher power versus production cost, and an order of magnitude lower T.H.D. than tube based amplifiers. During this period low efficiency acoustic-reflex loudspeakers became popular due mainly to their smaller size for the same subjective low frequency output. The decrease in efficiency of these designs was substantial, requiring 4 to 10 times more amplifier power. Additionally the impedance variations with frequency due to the under-damped woofers reactance are far more substantial than the older, large designs. These last two effects compound to make vacuum tube designs less attractive. In the popular press at the time the new amplifiers etch and glare where educated to the consumer as “detail”. These early amplifier designs are now universally considered un-listenable. An example is the resale value and current regard of the two most popular amplifiers of all time, the 1958 - 1990 Dynaco ST70 35W ultra-linear push-pull vacuum tube amplifiers and the later solid state brother, the Dynaco ST120. The ST70 can fetch up to \$500 on resale with an incomplete parts only chassis never less than \$200. I’ve noticed two separate transactions on Ebay where the ST120’s sell for less than \$20. Indeed the latest issue of Listener magazine proclaims the Stereo 120 “the worst sounding amplifier ever made”^[19] while the ST70 reviewed the “Classics” column “giving me some of the best-reproduced sound I have ever heard”. Why the discrepancy? It is now generally agreed that the early solid state circuits had insufficient slew rate in the driver sections for the large amount of negative feedback creating dynamic intermodulation distortions. The first work on analyzing this behavior was in 1970’s “Transient Distortion in Transistor

Audio Power Amplifiers”^[20] by Matti Ojala, followed by “Circuit Design Modifications for Minimizing Transient Intermodulation Distortion in Transistor Audio Power Amplifiers”^[21] He clearly shows how the slew rate of the front end gain stages and the feedback network must exceed the signal bandwidth by a factor related to the amount of negative feedback, at least 50 times for common applications. If this specification is not met dynamic intermodulation distortion is created. His work is universally embraced and founded the ultra-high bandwidth audio design era. In “A Method for Measuring T.I.M.”^[22] he proposed a method that yields quantitative measurements of dynamic intermodulation distortion without the knowledge of the out-of-band behavior of the test amplifier. He explains the use of a 15kHz sine wave and a 3.18kHz (low pass filtered at 15kHz) square wave. Total intermodulation distortion is given by Eq. 1-1. To

$$IM(\%) = \frac{100 \left[\sum_{n=1}^9 V_{nt}^2 \right]^{1/2}}{V_2}$$

Eq.1-1 where

V_{nt} = peak amplitude of component $f_2 - nf_1$

V_2 = peak amplitude of test sinusoid.

determine dynamic intermodulation distortion (D.I.M.) the 3.18kHz filtered square wave is used. Using a 3.18 kHz triangle wave instead results in S.M.P.T.E. I.M.D. T.I.M is then calculated via T.I.M. = D.I.M. – I.M.D. Ojala presents objective tests on eight audio power amplifiers and most show T.I.M onset earlier and far more severe slope than the

common the SMPTE I.M.D, reproduced in Fig. 1-6. His conclusion, documented by the far earlier onset of T.I.M, is that the minimum slew rates for closed loop op-amp circuits

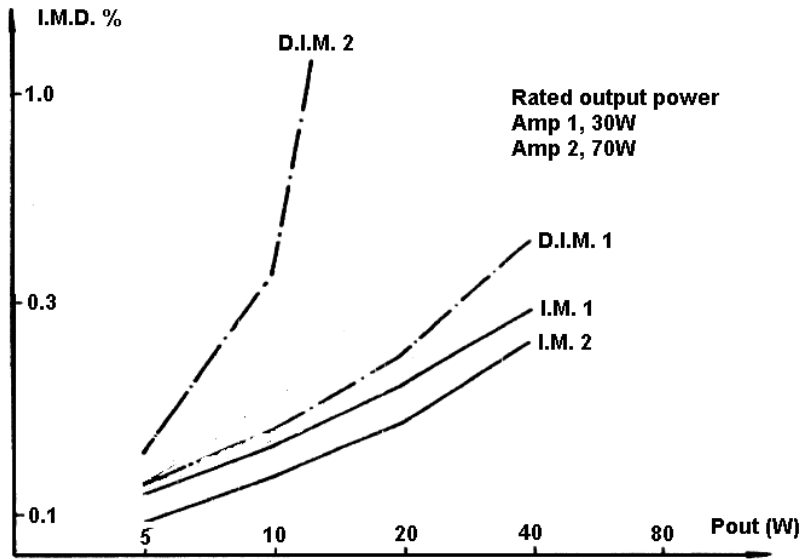

Fig. 1-6 Comparison of Dynamic I.M. with common I.M.D.^[22]

with 30kHz bandwidth be 10V/μs, and 100V/μs for power amplifiers. He states “These results show that even the fastest present amplifiers must remain suspect as far as T.I.M is concerned”^[22 pp. 175]. Inspecting the D.I.M versus I.M. family for the two amplifiers in Fig. 1-6 does show that I.M is an insufficient measure. Note amplifier no. 1, a 30W model, the D.I.M tracks with I.M, but for no. 2, a 70W model D.I.M. departs from I.M rapidly at less than ½ rated power. “The T.H.D and SMPTE-IM test methods give very low distortion figures, even when the quality of the amplifier as judges with other tests is completely unacceptable.”^[22 pp. 175].

One of Matti Ojala's later papers for the Journal of the Audio Engineering Society is 1978's "Correlation Audio Distortion Measurements"^[23]. Here he combines a 2 stage op-amp circuit with non-linear feedback elements to create the common amplifier distortion mechanisms. The conclusion table is presented below as Table 1-1. The THD

Distortion Mechanism	THD	SMPTE-IM	CCIF-IM	DIM	NOISE
Symmetrical Output Non-linearity	Poor(1) Good(10)	Excellent	Good	Moderate	Poor
Asymmetrical Output Non-linearity	Poor(1) Good(10)	Excellent	Poor	Excellent	Poor
Crossover Distortion	Poor(1) Excellent (10)	Excellent	Excellent	Poor	Poor
Hard Input-Stage Limiting	zero	zero	Poor	Excellent	Excellent
Smooth Input Stage Limiting	Zero(1) Poor(10)	zero	Good	Excellent	Excellent

Table 1-1 *Comparison between distortion mechanism and measurement type*

(1) and (10) indicate the total harmonic distortion at 1 kHz and 10 kHz respectively. SMPTE is total static 2 tone I.M. using the standard 7 kHz:200 Hz at 1:4 weighting. CCIF is I.M. sub harmonics of two tones at 14 kHz and 15 kHz. The NOISE test is performed by injecting band limited white, high-pass filtered at 48dB/oct. below 11 kHz. Noise spectral density is measured with a spectrum analyzer in the frequency range of 0-9kHz. Inspection of this comparison table reveals that no single listed amplifier testing method successfully measures all the discussed distortions. The NOISE and DIM tests are not commonly published on modern commercial equipment reviews. Input stage limiting performance remains an untested parameter.

For the period of the late 1970's on the audio testing literature concentrated on advances in testing resolution using the existing standard measurements previously discussed. The mid 80's brought both digital audio and one-box automated testing systems. Products such as the Audio Precision 1.0 became widespread, these used the graphical interface provided by the personal computer and provided quick tests with great repeatability but necessarily excluding any tests other than the common set available at the top-level software control. Notable during this period is a development by Richard Cabot, VP of Audio Precision of a complex test using multiple tones with distortion calculated as the summation of the power of signals not at the injected frequencies. The paper "Comparison of Nonlinear Distortion Measurement Methods" ^[24] introduces this method called the FASTtest. In the paper he uses 59 individual tones, as shown and described in Fig. 1-7. Non-linear components plus noise are detected and their value is

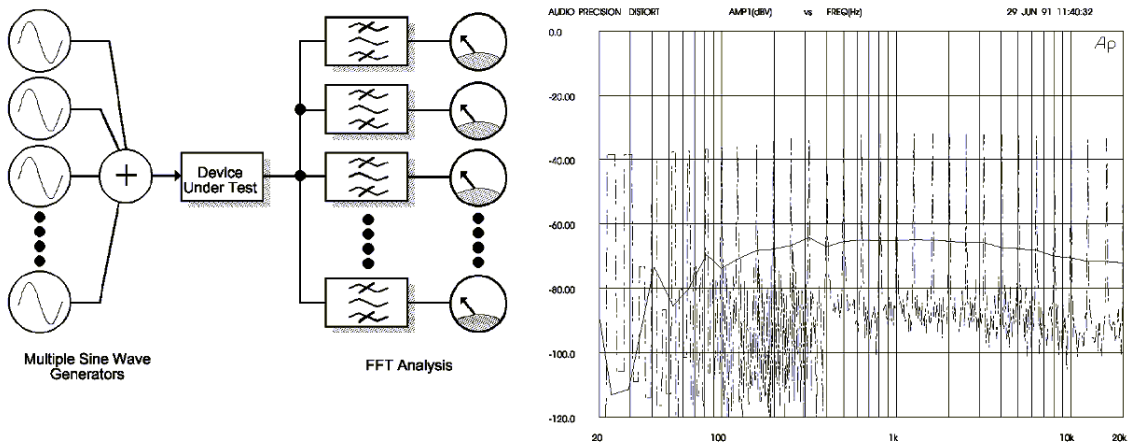

Fig 1-7. FASTtest Methodology and spectrum ^[24]

shown as the horizontal line in the right hand plot of Fig. 1-7. The performance of the FASTtest in comparison with the common tests is shown in Fig. 1-8. The left-hand plot is a simulation of harmonic distortion arising from output stage non-symmetry. The right hand plot is slew rate limiting. In general the curves follow the same family of behavior

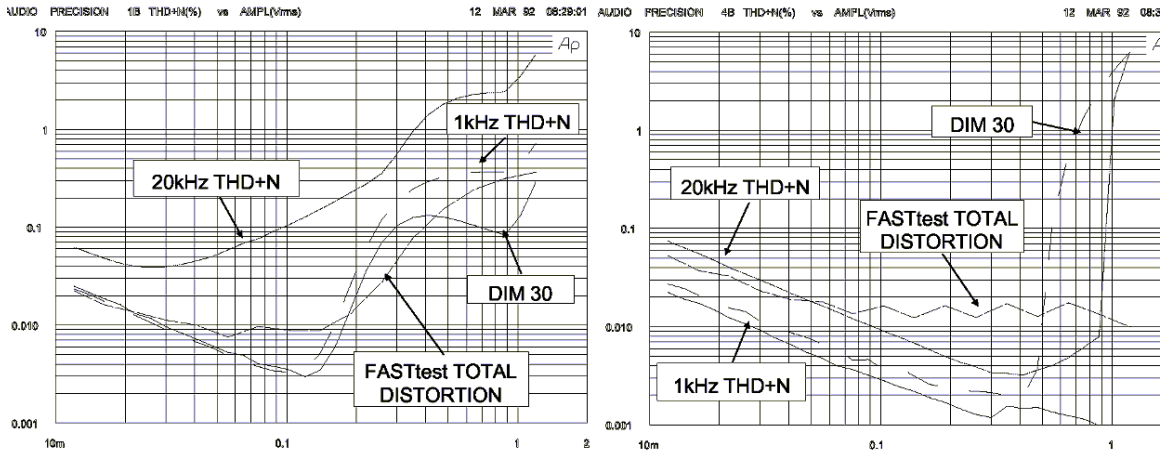

Fig 1-8 Performance comparison between FASTtest and other methods.^[22]

with no test method discernable as universally superior. Richard Cabot discusses the ability of the system to weight the test signal amplitudes to better match the frequency content of a musical signal. He does not mention any means for weighting the harmonic components order, presumably as the system does not attempt to calculate the harmonic products of each tone, but is rather an summation envelope of all tones harmonics. As will be shown in the following sections of this paper the FASTtest methodology will not produce measurements that better correlate with subjective quality than previous existing methods.

3. Examples of standard measurements

This thesis work encompasses many years of measurements on different amplifiers of differing designs. Presented is a full detailed analysis of two. The first is a Hafler DH500, a well-respected commercial high power push-pull amplifier using paralleled banks of MOSFET output transistors. The Hafler adequately represents the current state of the art. It is rated at .02% THD from 20-20kHz at 255 Watts per channel. The circuit is a typical modern no frills design of the philosophy that a simple signal path gives the best results. The feedback is single pole passively compensated via the

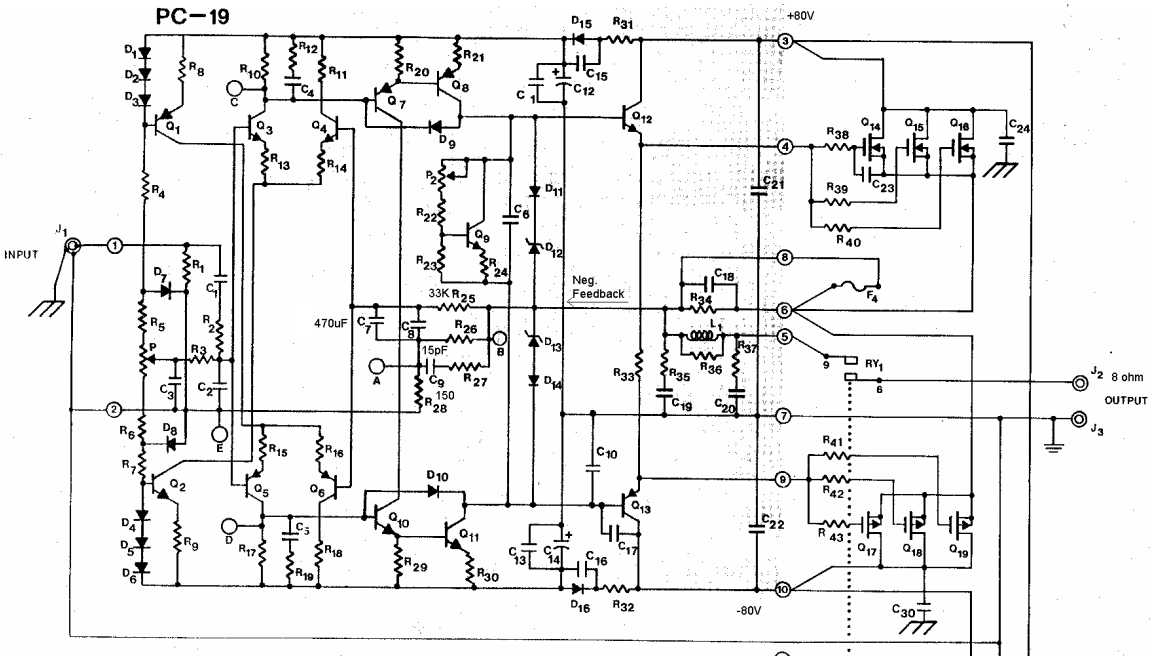

Fig. 1-9 Hafler DH500 audio power amplifier schematic, one channel shown.

components near the center of Fig 1-9 at a very low frequency $\sim 0.01\text{Hz}$

$$f_c = \frac{1}{2\pi * (470\mu F \parallel 0.1\mu F) * (33K\Omega)}$$

A differential stage sums in the feedback, followed by a Darlington voltage amplifier. The output transistors are biased on to $\sim 1\text{ W}$ by biasing the output driver transistor into partial conduction to help prevent crossover distortion due to the low Gm of the MOSFETs near cut-off. Symmetry between the N and P channel MOSFETs is limited and negative feedback is required to reduce the large 3rd harmonic distortion that would otherwise be present. Transconductance drift with temperature is not shown on the data sheets. Two points were tested, ambient and 100C° . Results show reasonable tracking, promising that output stage shifts during transient thermal effects do not tax the feedback loop excessively as this type of non-linearity is truly non-harmonic.

Measurements were performed by instrumenting the Hafler DH500 in the following manner, shown in Fig. 1-10. Measurements were taken with the \$26,000 Hewlett-Packard 35670A Dynamic Signal Analyzer¹³. This instrument is this the state-of-the-art in terms of un-averaged on-screen resolution, with its front end meeting specification over 75dB dynamic range. Averaging the sweeps affords another 30-40dB dynamic range. The instrument includes un-weighted standard T.H.D analysis of up to 20 harmonics, and a low distortion signal source of large signal swing and offset, and 4

¹³ Graciously lent to my home lab by my employer, M.I.T. The D.S.A. was originally purchased for R&D in the S.S.C. laboratories.

floating input channels. The required test signals for the standard measurements are generated by either the HP35670A internal sine source shown as connection A in Fig. 1-10, a Singer TTG-3 two tone generator shown as connection B, or a combination of one tone of the TTG-3 and a HP 8116A 50MHz pulse generator shown as connection C. The L.P.F. (low pass filter) is required for the D.I.M tests and is a 6dB/octave passive network with a -3dB point of 20kHz. The D.S.A. is used in two channel mode, with the test signal input on Ch. 1 and the amplifier under test output on Ch.2. The ability to measure the distortion of the input test signal in real time allows any residual distortion of the test

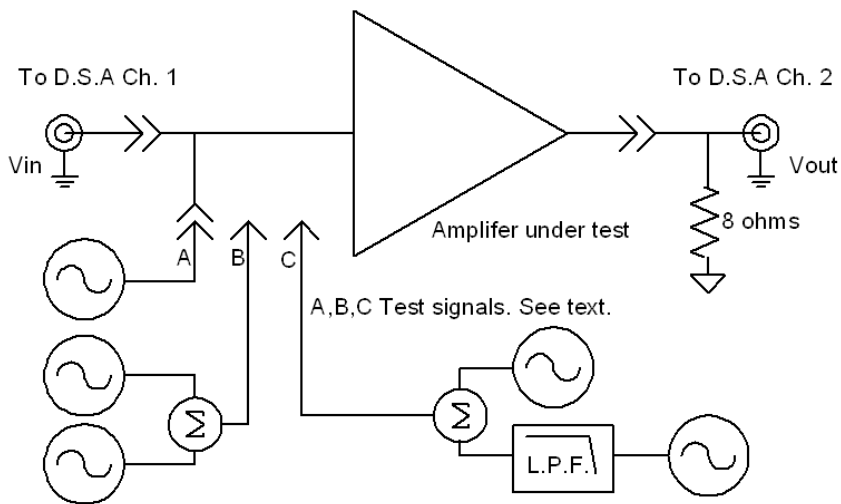

Fig. 1-10. Block digram of test set-up.

signals to be nulled-out in post-processing. The amplifier is loaded by a standard 8ohm resistive load. The Hafler DH500 measurements are shown following. Frequency response was less than 1db down at 20kHz and is not shown. One kHz THD was less

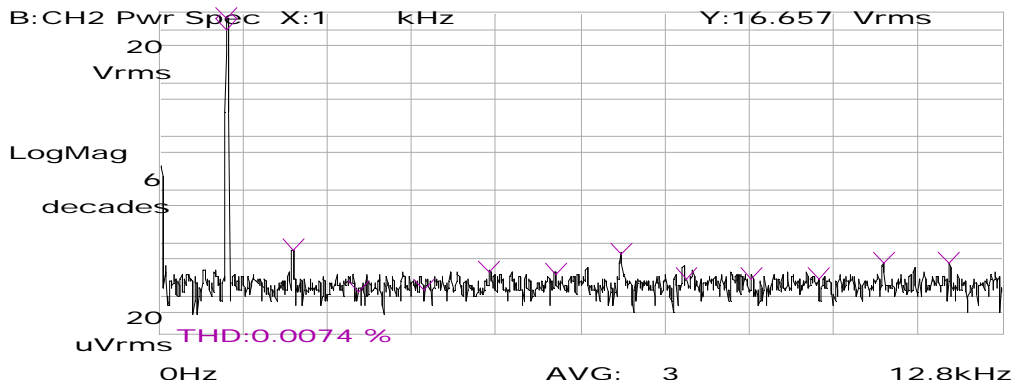

Fig 1-11 *DH500 Distortion components and T.H.D at 1 kHz, 32W.*

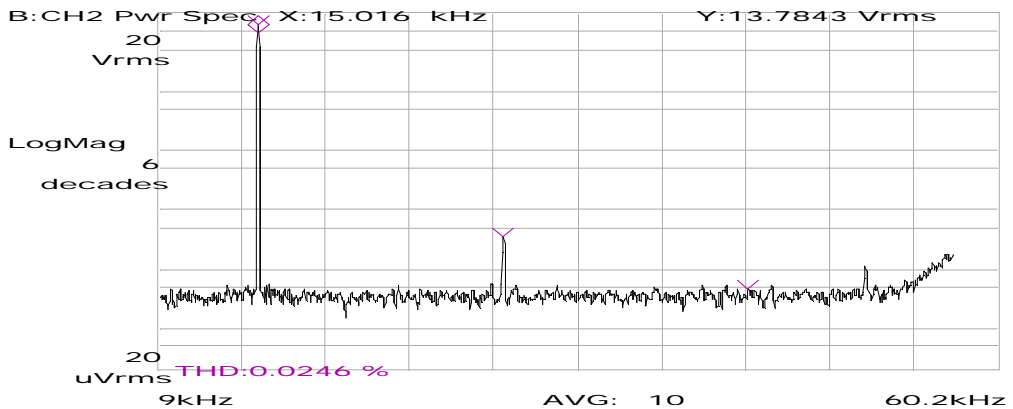

Fig. 1-12 *DH500 Distortion components and T.H.D at 15 kHz, 23W.*

than 0.01% at output powers to 200W. Shown in Fig 1-11 is 32W, 1kHz. At 15kHz & 23W the second harmonic is at 0.026%, shown in Fig. 1-12. The previous two measurements used the HP35670A internal source, connection A on Fig. 1-10. Intermodulation measurements gave excellent results. Connection B in Fig. 1-10 is used, and the test generator tones are set per the requirements of the specific common I.M. tests. I.M. 200:7K at 1:1 ratio showed no static intermodulation products. I.M. 4K:15K

again shows flawless I.M. performance, shown in Fig. 1-13. The upper trace is an FFT of the input signal showing the self I.M.D. of the signal generator/mixer. The lower trace

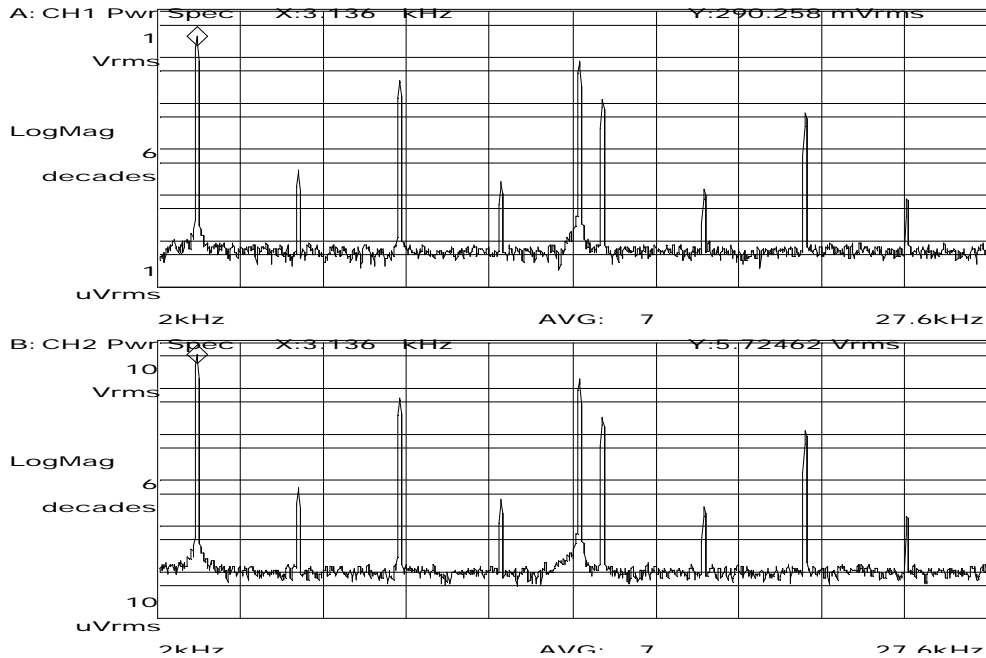

Fig 1-13. *DH500 Intermodulation Distortion, 4kHz:15kHz at 4W.*

is the output of the DH500 at 4W. No additional IM products are discernable. Dynamic intermodulation (D.I.M.) tests used connection C in Fig. 1-10. D.I.M. 3.18kHz:15kHz the DH500 also did not add measurable dynamic IM products, as shown in Fig. 1-14. Again, the upper trace is the input/test signal, the lower trace the amplifier output, with the 3.18kHz sine at 10W R.M.S. Comparing Figures 1-13 and 1-14 show that no additional D.I.M. is measurable in the amplifiers output when the 15kHz square wave is modulated

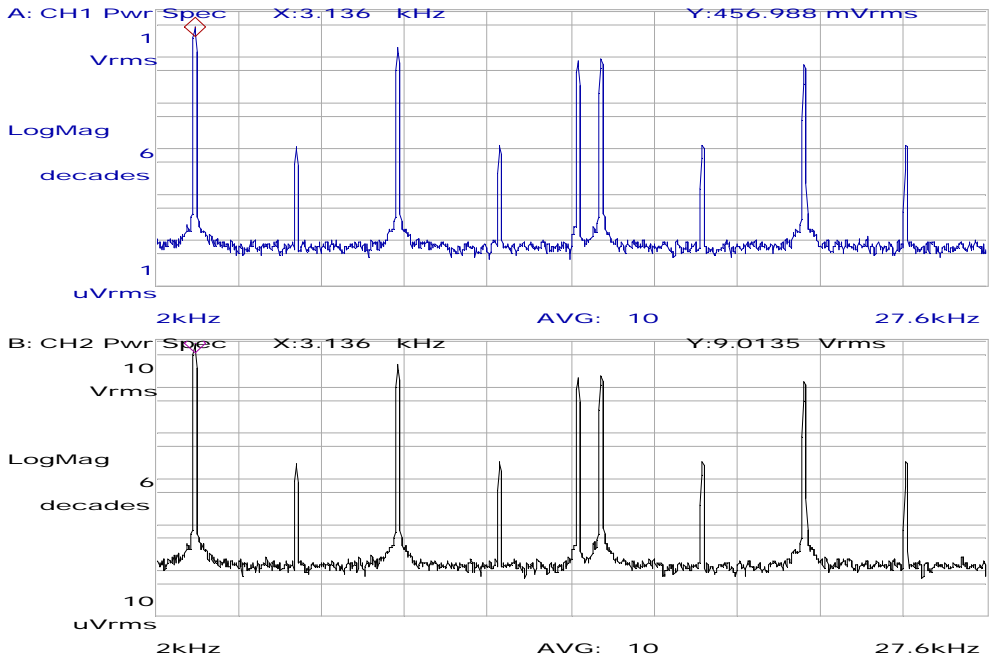

Fig. 1-14 DH500. D.I.M, per Otała, 3.18kHz:15kHz,10W

with the 3.18kHz sine, as per M. Otała's procedure. This amplifier tests flawlessly in all standard tests.

The second amplifier that is fully detailed is a 1.5W per channel single-ended tube amplifier designed by myself using type 45 directly heated triodes developed in 1926. The type 45 produces the most linear open loop transfer characteristic ¹⁴ over a large portion of its operating range of any device I have tested, solid state or otherwise. The type 45 was designed for audio frequency power amplification and can withstand

¹⁴ In Chapter 2 I show that the open-loop behavior of an amplifying element strongly determines the end circuits subjective sound quality.

275V on its plate, can sink 36mA, and has a gain of 3.5 Siemens. The amplifier is designed to present the output tube with its ideal load of 5800 ohms via the use of a very high quality output transformer. A short discussion of the theoretical merits of the single ended output stage is necessary. Accepting the use of an antique triode because of its open loop linearity forces us to use an impedance matching transformer, which is common. A transformer is nearly perfectly linear except for the region near zero flux and near saturation. In both these regimes the slope of the BH curve is lower than in the linear region. If the signal traverses the region near zero flux odd-order harmonic distortion is produced. In Chapter 2 section 1 it is discussed that this distortion is audible and in Chapter 2 section 5 it is explained in detail why the use of negative feedback is not a solution to this non-linearity. A single ended design by its nature sinks a DC current of half the peak current thru the output transformer. This forces the operating range away from the two non-linear zones. The schematic is shown in Fig. 2-6. The driver stage is necessary to match the voltage gain to the DH500 previously discussed. The type 26 directly heated triode was again chosen for its linearity. The gain of the driver is set to times 35. Measurements were taken with the same setup as the Hafler DH550, shown in Fig. 1-10. The load is the same 8 ohms. The finished amplifier has a respectable full power frequency response of $\pm 0.5\text{dB}$ 20Hz to 15kHz shown in Fig. 1-15. This plot is generated by a sweeping function of the HP 35670A. The -3dB HF point is $>30\text{kHz}$.

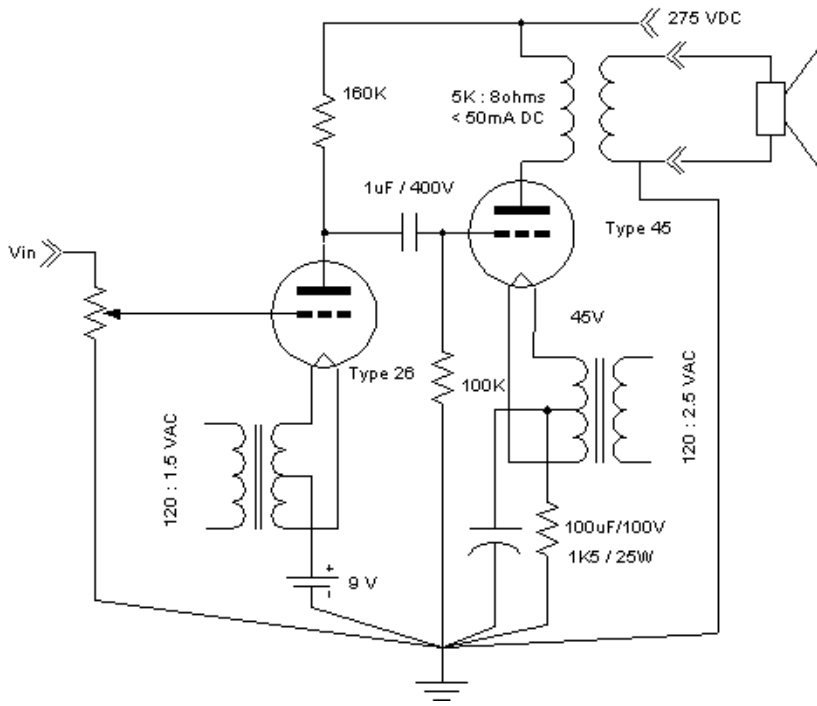

Fig. 1-15. Schematic of the type 45 triode tube based Single-ended audio amplifier

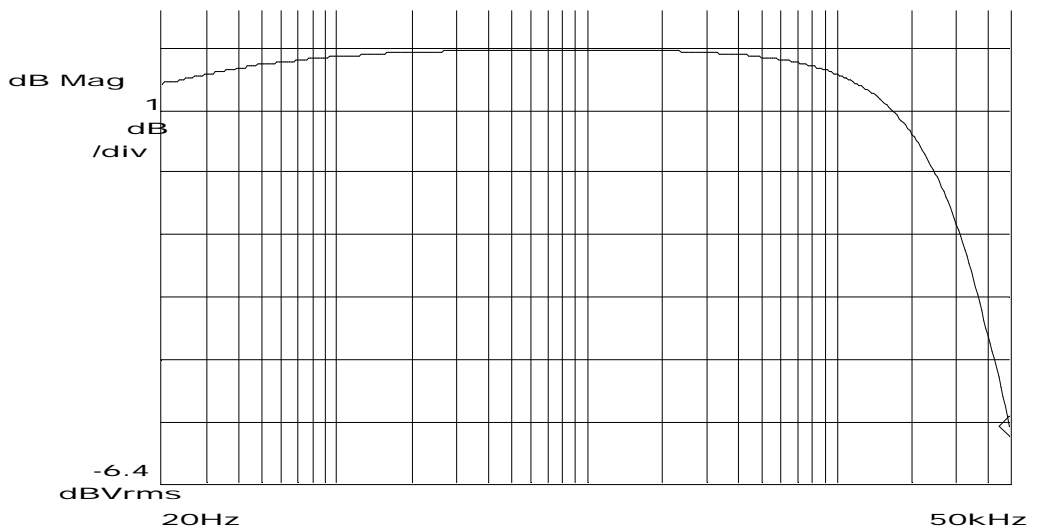

Fig. 1-16. Type 45 S.E. amplifier frequency response.

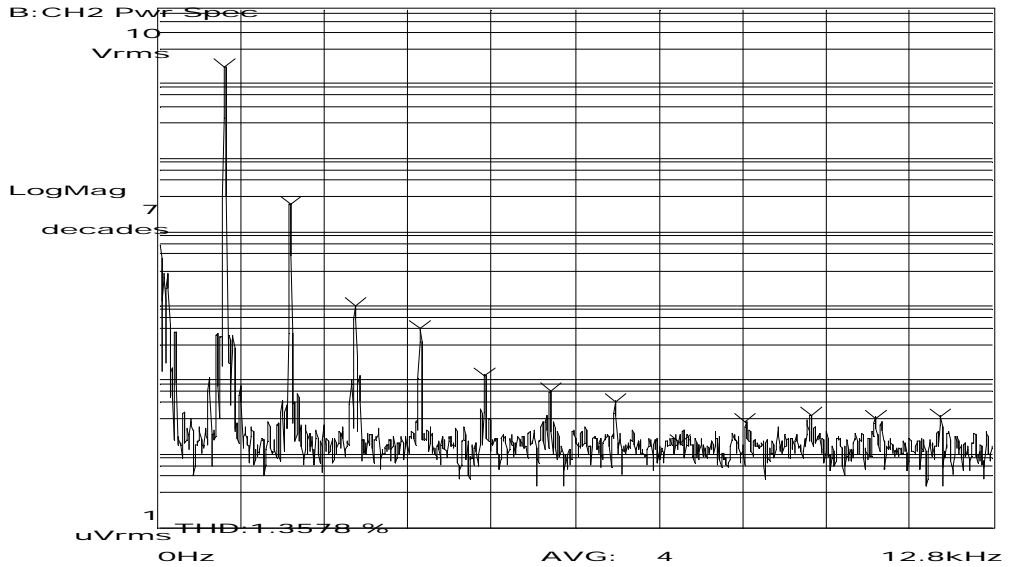

Fig. 1-17. Type 45 S.E. amplifier 1kHz harmonic distortion components at 0.4W

T.H.D. with a 1kHz sine input was 1.36% at 0.4W output, shown in Fig. 1-17. Connection A on Fig. 1-10 is used. Note the 60Hz AC filament heater noise creates closely spaced I.M. products around the harmonics. The 200Hz-7kHz I.M. performance

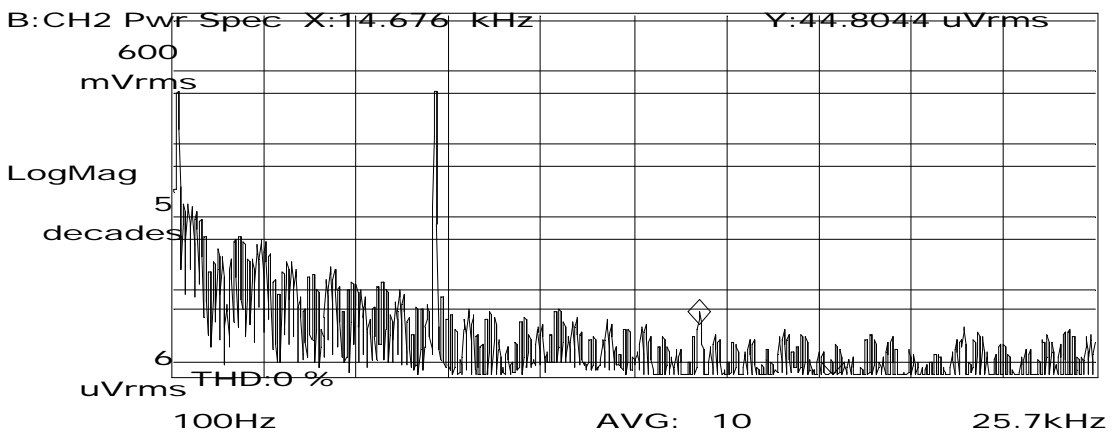

Fig 1-18. Type 45 S.E. amplifier 200Hz-7kHz IM.

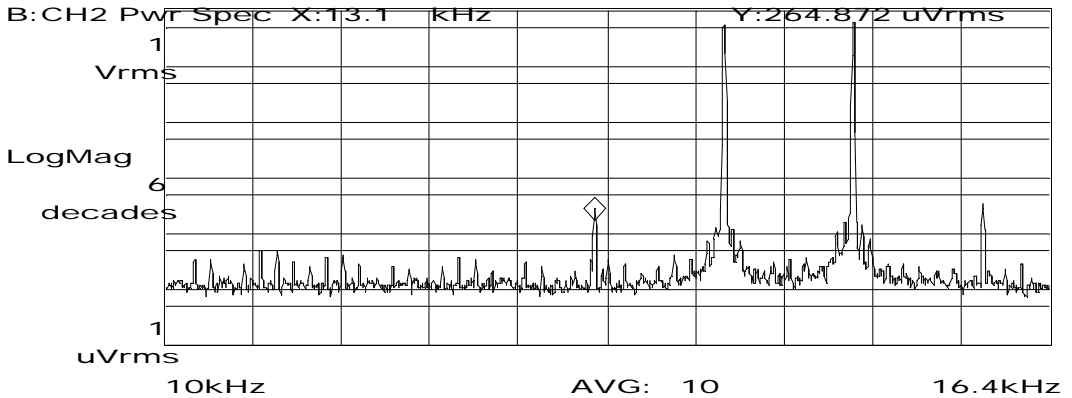

Fig. 1-19. Type 45 S.E. amplifier 14kHz:15kHz IM.

was 0.08% as shown in Fig 1-17. IM using 14kHz:15kHz is shown in Fig. 1-19. The IM product at 13kHz is 264 uV compared to the 14& 15 kHz at 637mV. This is less than 0.0001%. Static I.M. measurements used connection B on Fig 1-10. The D.I.M tests at

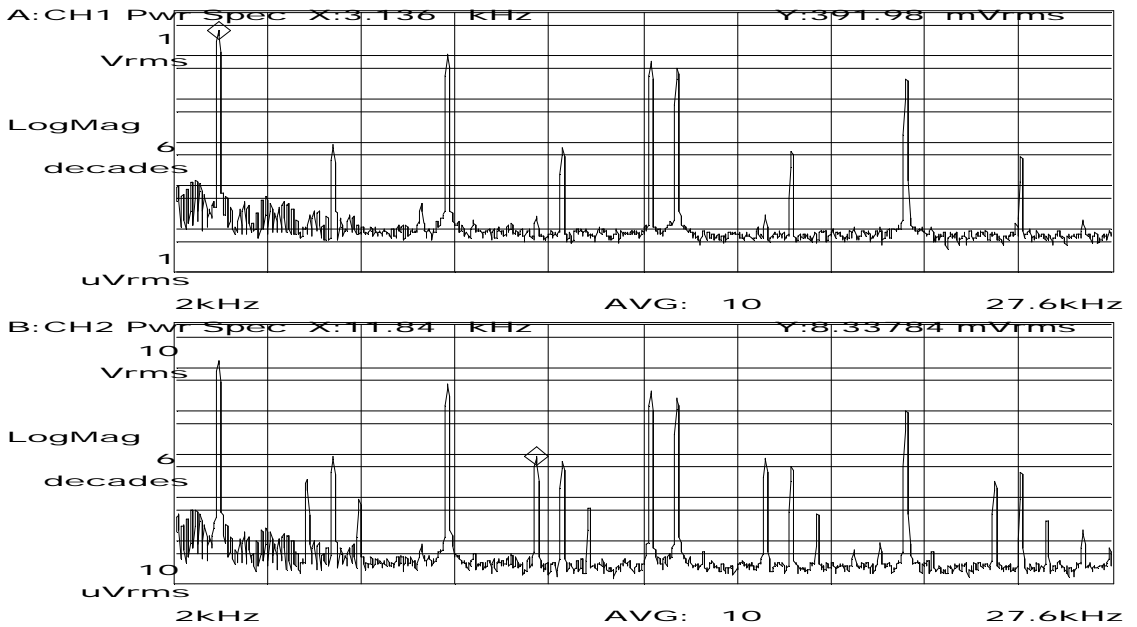

Fig. 1-20. Type 45 S.E. amplifier D.I.M.

higher power outputs show significant static IM products, as shown in Fig. 1-20. What is notable is that when the 3.14kHz triangle wave was changed to a square wave no additional IM products were detectable. This exact similarity between the static and dynamic IM measurements is due to the lack of any negative feedback in this amplifier. There is no mechanism to create intermodulation other than the first pass through the gain devices non-linearity.

4. Conclusion. A call for a new methodology

The previous standard measurements clearly show the perfection of the high power solid- state design and the horrible “performance” of the zero feedback. Yet, in listening tests¹⁵, the single ended tube amplifier was unanimously judged as sounding closer to the truth. It seemed more dynamic. It had less “grain”¹⁶, especially in the mid-range. It seemingly had higher resolution as it presents a better “imaging”¹⁷ sound field.

There has been a failure in the attempt to use specifications to characterize the subtleties of sonic performance. Amplifiers with similar measurements are not

¹⁵ Although a strict scientific experiment was conducted comparing the amplifiers I do not present an detailed analysis here. In summary, the type 45 amplifier was chosen as preferable 100% of the time by all the different listeners (5) in a “single-blind environment”, meaning, the listener toggled a remote push button and either the amplifiers were swapped or not. A numeric display was incremented at each selection and the listener noted if the amplifier changed or not, and if the change was to the one preferred. I attended all sessions and verified that levels were matched, that there was no clipping, and the program material kept within the flat pass-band of the type 45 amplifier-speaker combination. The source was a live piano microphone feed.

¹⁶ The audiophile press has varied colloquialisms to describe sound coloration. “Grain” is a common term referring to a the interpretation of low level non-harmonic noise added to the signal.

¹⁷ “Imaging” refers to the clarity of the perceived stereo sound field. Commonly the better the “imaging” the easier the listener can resolve the spatial locations of individual instruments.

equal, and products with higher power, wider bandwidth, and lower distortion do not necessarily sound better. For a long time there has been faith in the technical community that eventually some objective analysis would reconcile critical listeners subjective experience with laboratory measurement. Maximum intrinsic linearity is desired. This is the performance of the gain stages before feedback is applied. Experience suggests that feedback is a subtractive process; it removes distortion from the signal, but apparently some information as well. In many older designs, poor intrinsic linearity has been corrected out by large application of feedback, resulting in loss of warmth, space, and detail.^{18, [25]}

Over the past 10 years a clear trend has surfaced; designs at the higher end of cost in a product line are enjoying decreased amounts of feedback, possible through the use of more linear gain stages. In all recent cases, these quality products measure significantly poorer in all accepted mainstream tests. Examples are the \$15,000.00 Conrad-Johnson companies model ART where the design chose 0 feedback over the design goal of reducing the previous generations 12db of NFB to 3db. This minimalist single stage design measures worse than their entry level products. The Cary Audio 805c has an adjustable feedback selector – 6dB, 3dB, 1.5dB, and 0, with 0 setting receiving widespread praise as “removing the pervasive graying of expression”^[26]. The Audio Research Reference line is another example of a product that uses less gain stages at a premium price. Even the marketing dictated major hi-end hi-fidelity equipment manufacturing companies of Mark Levinson, Cello and Krell are moving toward more linear gain blocks allowing for lowered feedback levels. All this movement is in strict

¹⁸ A quote by Nelson Pass, President of Pass Laboratories, from the Passlabs.com website. Mr. Pass is one of the most prolific inventors in audio. He designed all the Threshold and Phase Linear line. Pass Laboratories specializes in large MOSFET based single-ended audio amplifiers and pre-amplifiers.

opposition to the current, standard, accepted measurements that drive “specifications”. This trend indicates that there needs to be a revision to the current measurement methodology if the goal of audio equipment specification is correlation with subjective sound quality.

CHAPTER II

A NEW AUDIO TEST PHILOSOPHY

Offered are my precepts that lead to a new test methodology that derives results that better correlate with subjective sound quality. These are examined in the subsections following.

- 1) The ears' self generated harmonics mask external harmonic distortion that has the same character. The ears' harmonic distortion is fully studied and falls off at a rate of approximately 10^n , where the power n designates the harmonic number. I propose that external harmonics strictly adhering to this envelope are fully "undistorted" by our ear-brain system and are thus indistinguishable from pure tones. An analytical derivation of conformance to this aural harmonic envelope is developed.
- 2) The increase of aural harmonics follow sound pressure level increases non-linearly and at different rates per harmonic. Therefore absolute system S.P.L.¹⁹ must be considered.
- 3) Intermodulation distortion is masked by this same mechanism. Amplifier topologies exist that are free from dynamic intermodulation affects, and whose residual intermodulation is linearly related to harmonic distortions.

¹⁹ Sound Pressure Level.

- 4) The character of the noise envelope within a sound transient is important to the brains recognition system. Noise floor pollution via low level high order I.M. products are to be avoided.
- 5) No current standard static or dynamic tests or other instrumentation based measurements correlate sound quality with levels of negative feedback. There is ample correlation between harmonic measurements and sound quality with devices that use no negative feedback (transducers and zero feedback electronics). It is proposed that audio gain stages be analyzed using weighted²⁰ T.H.D, I.M.D., and other tests, with all loop feedback disconnected.

1. Harmonic Consonance.

The cochlea is the portion of the inner ear devoted to hearing. It is a 35 mm long spiral fluid filled tunnel of reducing aperture embedded in bone with 12,000 outer hair cells spread every 10 microns in sets of 4, each tuned to a different frequency. Studies via instrumenting²¹ sets of outer hair cell neurons have verified the creation of harmonics within the cochlea, documented in the 1924 figure^[28] Fig. 2-1. This work is the result of

²⁰ As notes in previous sections, higher order harmonics are increasingly more detectable by the ear-brain system as audible distortion.

²¹ Studies were performed on cats^[27]. No studies were found on the human ear system that directly measured the hair cell transducer harmonics due to the mechanical limitations of the hair-cochlea interface. The geometry and cell type are very similar, and, other indirect methods of measuring the aural harmonics have been thoroughly developed.

speech recognition studies. Shown are the ears self created harmonics relative intensity versus fundamental frequency. The data was derived by using the understood

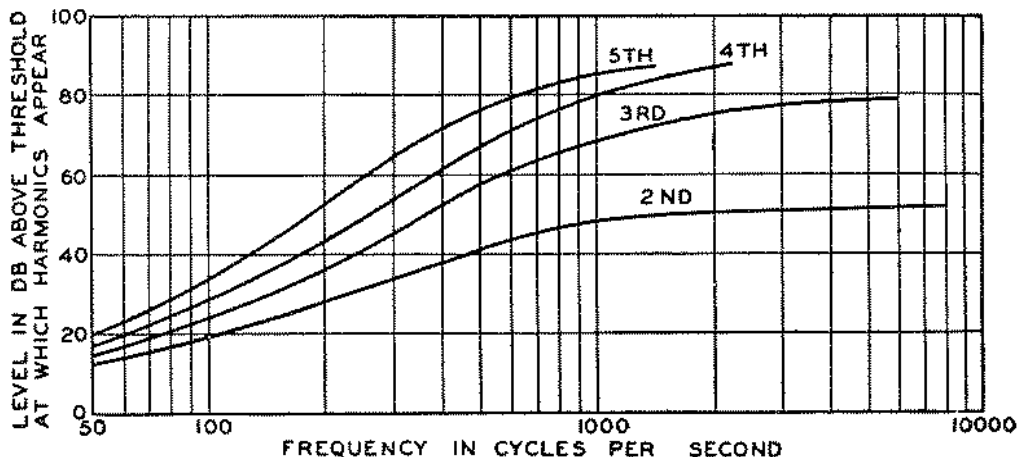

Fig 2-1. Ear self-generated harmonics, frequency versus level.

phenomenon of hearing beating when two notes are impressed on the ear. An auxiliary tone of a frequency near the fundamental test tones' harmonic is used and its level raised until beating is just audible. This level is related to the ears natural aural harmonic creation. Inspecting this data, the second harmonic of a 1kHz fundamental tone²² is 50dB above the threshold of hearing. In 1967 Olson^[28] from RCA/Victor R&D Labs continued testing the first 8 harmonics and over a broad range of sound pressure levels, reproduced here in Fig. 2-2. This has been redrawn for clarity in Fig 2-3. Notice that the ear creates significant levels of the second harmonic, nearly 10% of the fundamental for sound pressure levels (SPL's) of 90dBA and above. Also the slope of the harmonic

²² The sound pressure level was not cited in this work. One assumes speech level, ~70dBA.

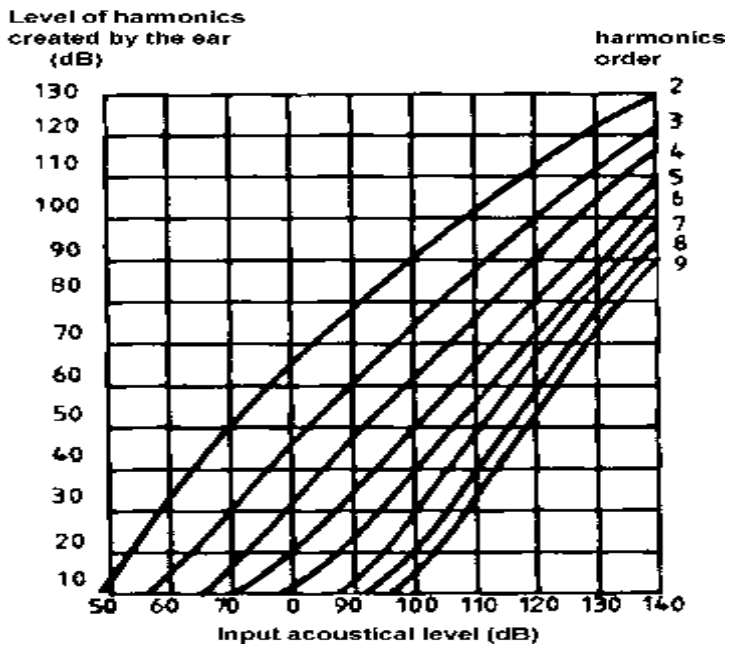

Fig. 2-2. Ear self-generated harmonics, level versus sound pressure level

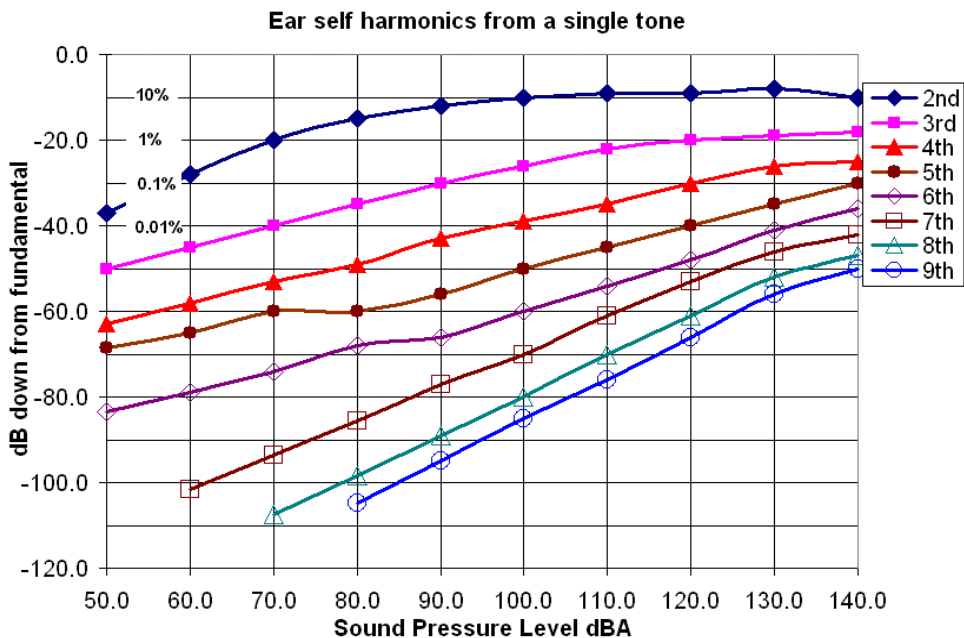

Fig. 2-3. Ear self-generated harmonics, level versus sound pressure level

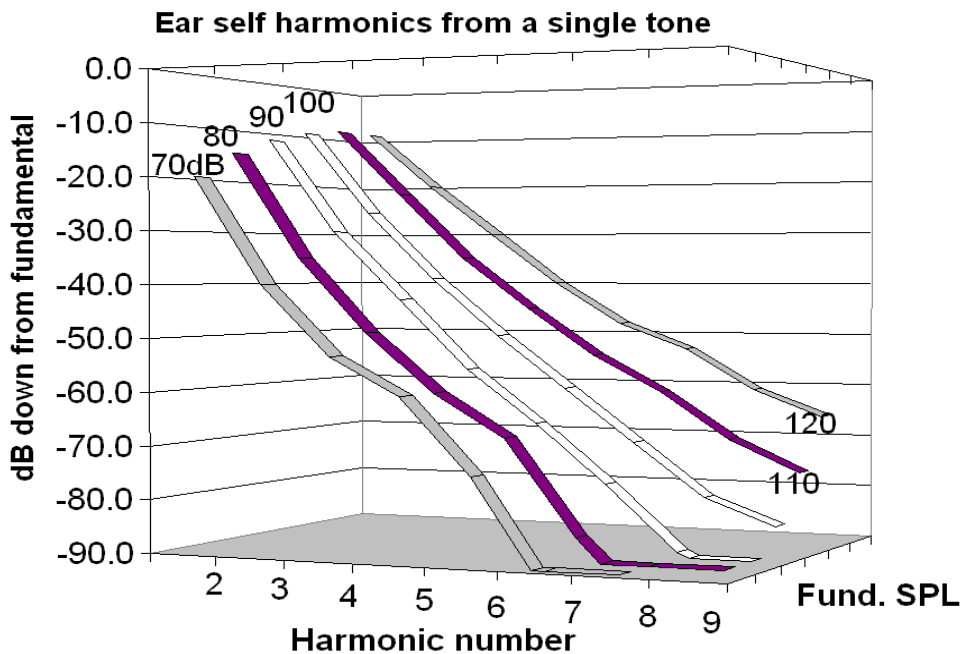

Fig.2-4. Subset of Fig. 2-3 with reduced SPL range for clarity

reduction versus input reduction varies with the harmonic power, beginning at approximately 1:10 for the 3rd harmonic to 1:1 for the 9th harmonic. A different perspective is shown in Fig 2-4. A reduced SPL range is shown. Even for the moderate S.P.L. of 80dBA, the 2nd harmonic is at the equivalent of 65dBA or normal voice level, and the 3rd at 45dB. This is still ~40dB above the mid-band threshold of hearing, yet one does not hear the harmonics! Only a single pure tone is heard. The ear/brain appears to be able to completely suppress the sound of a range of harmonics if they conform to this specific pattern. This pattern is the aural harmonic envelope. It follows that this same mechanism will mask harmonics arising in the sound reproduction chain if they follow this pattern. If the harmonics do not follow this pattern, the ear brain indeed detects these

as new tones. Therefore, for all but extreme frequencies and sound pressure levels, any electronics that generate this harmonically consonant envelope will be transparent. Previous work has shown that people had a strong preference for a signal with 0.3% artificially injected even-harmonics that had 0.03% odd-ordered harmonics [29]. Note that for the predominant 2nd and 3rd harmonic this better mimics the aural harmonics.

The above discussions are conscious of the well understood ear's phenomenon of masking, where low level tones in close proximity to a higher level tone remain unheard. This masking effect was thought by some²³ to be one of the rationales for weighting the higher order harmonics stronger in weighted T.H.D. measurements. Fig. 2-5^[33] following shows the pitch change necessary to distinguish a second tone. Note

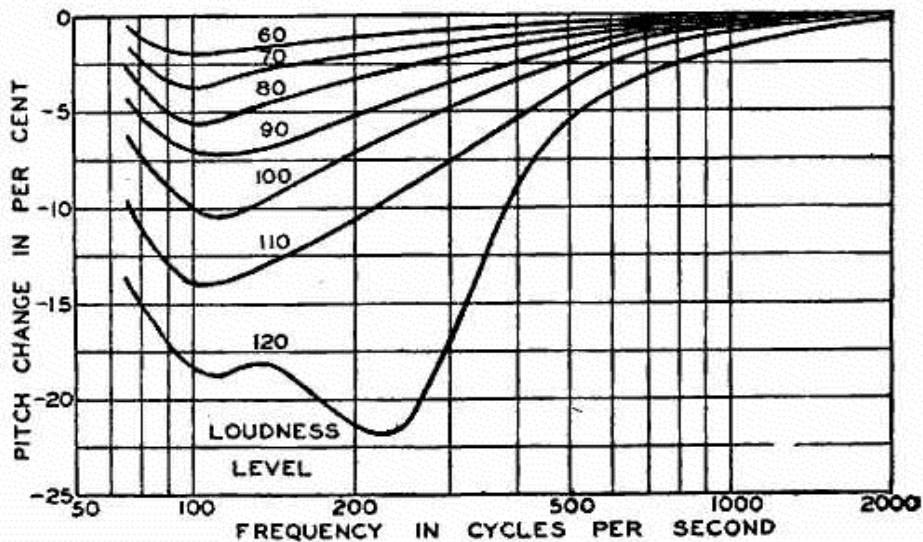

Fig. 2-5 Pitch change necessary to distinguish a second tone

²³ References [30], [31], [32]

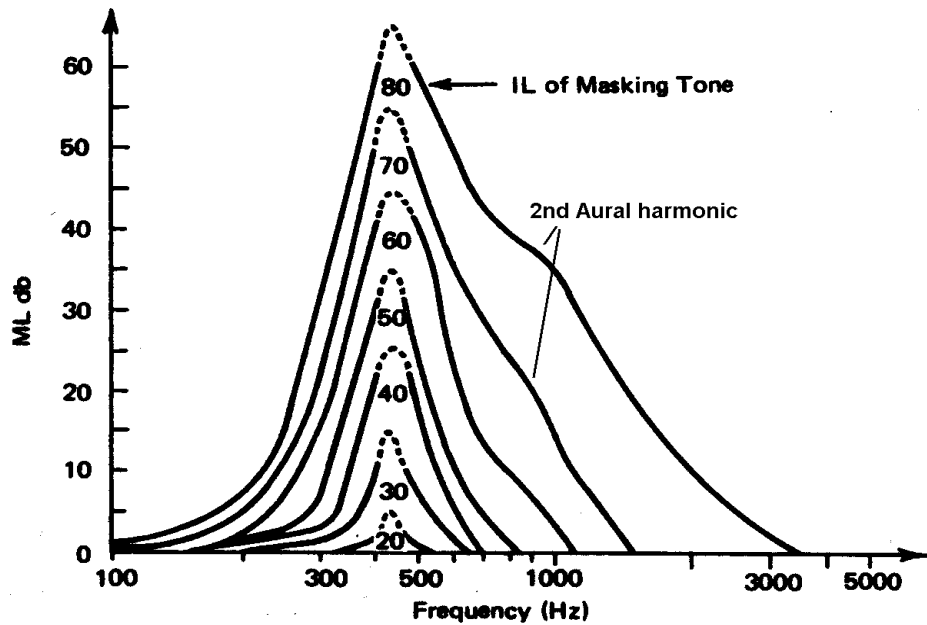

Fig. 2-6. *Tone masking research showing aural harmonics*

that harmonics are at 100% pitch change. Fig. 2-6 ^[34] actually shows that the aural harmonics have a stronger influence than masking, note the lack of symmetry about the fundamental (415Hz) and the shoulders of the 2nd harmonic. The aural harmonics play a more prominent role than the ears masking mechanism. There was no correlation between age and sex in these or other studies of aural harmonics. There are significant sex and age differences on most other aspects of hearing, namely frequency extension. These are due to the macro effects such as ear tunnel geometry or exposure damage. These effects are not investigated herein as they are presumably not involved with the ear-brains system of self-correcting for the aural harmonics.

2. The sound pressure level dependence of the aural harmonic envelope.

The dynamic range of individual hair cell neural output is about 10^3 , while the range of audible sound pressure levels is about 10^5 . The latest studies have shown that the hair cells' length is modulated by the neural voltage and this is believed to explain the compression [36]. As was shown in the preceding section the aural harmonics do not fall off at the same slope either by harmonic number or linearly with decreasing sound pressure levels. For rising S.P.L.'s the ear creates a monotonically reduced steepness pattern. We cannot disregard this function of the ear. For example, if the ear is presented with an auxiliary sound distorted with a set of harmonics that are consonant with the aural harmonics at 100 dBA²⁴ but the actual sound pressure level of the fundamental is say 10 or 100 times (10 or 20dB) less, it will be perceived as distorted. The Eq. 2-1 which

$$\% F_n = \frac{1.35 * 10^{\left(\frac{dBA}{22}\right)}}{n^{11}} \quad \text{Eq. 2-1}$$

Where: $\% F_n$ = Aural Harmonic Amplitude in % of Fundamental for the n^{th} harmonic.

dBA = Decibels "A" weighted Sound Pressure Level resultant from the Fundamental.

n = The harmonic number. $f = nF_f$ where f is frequency,
 F_f = fundamental frequency

²⁴ dBA is the commonly used absolute measure of loudness for humans. It is filtered by an approximate inverse of the ears sensitivity variations over frequency. The A designates the standardized A weight filter.

I derived myself²⁵ from the Olson data is presented and takes the sound pressure level variation into account. It is a mathematical expression relating the percentage of the fundamental S.P.L. of the ears self distortion, per harmonic, relative to the sound field S.P.L. The power of the exponentiation may seem high but the fit is excellent, shown following in Fig. 2-7. The solid data points are the data taken directly from the Olson figure reproduced earlier as Fig. 2-2. The hollow data points are calculated from Eq. 2-1.

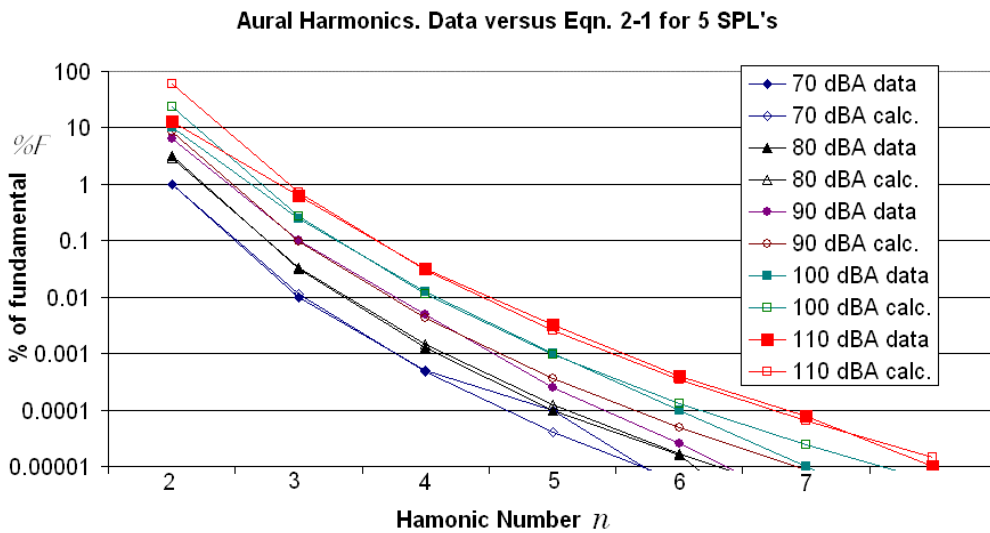

Fig. 2-7 Showing fit of Eq. 2-1 versus Olson aural harmonic test data^[28].

For the highest SPL's a compression of the 2nd aural harmonic is noticed. This error of the fit is acceptable as these levels are very high. For normal music reproduction in the home (levels of 90dBA peak) the fit is very good, to 0.0001% of fundamental, or about 30dBA, which is below the noise floor of a normal listening environment. An ideal amplifier

²⁵ This equation was derived by first using curve fitting algorithms and then hand manipulated using spread-sheet tools until the error bars where minimized.

would contain no harmonics that do not conform to this aural harmonic envelope. It is proposed that the relative deviation between an amplifiers distortion harmonics and the aural harmonics, per harmonic, must better quantify the detectable error of the amplifier and therefore the subjective sound quality of an amplifier. The better sounding amplifier will have either no harmonics or those that are present must strictly conform to the aural harmonic envelope. In testing many different amplifiers their harmonic signature did not follow the aural harmonic envelope. Universally the distortion has high order harmonics without the next lower order harmonics' complementary level. Contrary to the history and evolution in audio design, high order harmonics, if they appear, **MUST** be joined by a family of lower order harmonics that follow the aural harmonic envelope. In calculating the magnitude of an amplifiers deviation for the aural harmonic envelope I propose that each harmonics deviation be on a relative basis (% of reading, referenced to the level of the n^{th} aural harmonic derived from Eq. 2-1), rather than on the absolute percentage referenced to the fundamentals level. This puts a very strong weighting on the higher harmonics and thus demands state-of-the art signal to noise ratios in the instrumentation. The \$29,000 H/P 3458 Dynamic Signal Analyzer used for this thesis is state of the art, with a 5 decade on-screen dynamic range. This limitation corresponds to approximately 0.001% of fundamental²⁶. This limitation is reasonable, in that the S.P.L of the amplifiers

²⁶ The dynamic range of a spectrum analyzer can be extended by the use of a calibrated notch or steep high-pass filter to remove the fundamental. This technique was not used herein mainly due to the wish to correlate all the readings for all the amplifiers tested at all frequencies without individual normalization.

harmonics at the 0.001% level are very near the threshold of hearing for moderate listening levels. The equation below has been developed for calculating a so named Total Aural Disconsonance, or T.A.D, a dimensionless figure of merit.

$$T.A.D = \sqrt{\sum_{n=2}^{20} \left(1 - \frac{H_n}{\frac{1.35 * 10^{\frac{dBA}{22}}}{n^{11}}} \right)^2} \quad \text{Eq. 2-2.}$$

Where: T.A.D. = Total Aural Disconsonance, the r.m.s. sum of the absolute deviation of an amplifiers n harmonics from the aural harmonics.

n = Harmonic number. Usually does not exceed 20.

H_n = measured level, in % of Fundamental, of the n^{th} amplifier harmonic

NOTE: if the denominator, $\frac{1.35 * 10^{\frac{dBA}{22}}}{n^{11}}$, is less than the noise floor, then it should be replaced with the noise floor.

The T.A.D. figure can be quoted alone, the goal of a generalized method of documenting audio amplifier quality. Many previous attempts at better correlating subjective quality with measurements, as previously discussed, have recommended either the weighting of harmonics components in the T.H.D calculation or specifying individual harmonics' % distortion. The T.A.D. method is the first to use psycho-acoustic based data to weight the individual harmonics. The range of amplifier T.A.D figures can be 100 for very good to 10,000 for very flawed. Several proposed methods of calculating T.A.D. follow.

1. By inspection.

A spectrum analyzer of sufficient dynamic range performs the measurements. The individual harmonic levels, in % of fundamental, are divided by the data in Figs 2-2 or 2-3 or Table A-1 in the Appendix. This results in a percent deviation per harmonic relative to the aural harmonic level. An R.M.S. sum is performed to result in the dimensionless T.A.D. For example lets examine the conformity to the aural harmonics of the two amplifiers harmonic distortion shown below. The first is the single-ended type 45 Triode amplifier from Chapter 1, followed by a 10W bi-polar push-pull feedback amplifier of marginal quality. Output powers at the measurements taken were 0.32W and 0.72W respectively (the distribution of the harmonics of either amplifier remained similar at matched output). Using a moderate to high efficiency speaker of 95dBA/1W/1m at near-field the respective fundamental S.P.L is 91dBA and 94dBA respectively. Using equation Eq. 2-1 the following aural harmonics are created at these S.P.L's. The amplifier measurements shown in Figures 2-8 & 2-9, summarized in Fig. 2-10, and the resulting Total Aural Disconsonance is derived and tabulated in Table 2-1. The resulting T.A.D is 365 for the triode amplifier and 7540 for the transistor amp. Indeed the Single ended triode power amplifier, with the lower T.A.D. figure sounded far superior to the low quality transistor amplifier with the most significant improvement being freedom from

A: CH2 Pwr Spec		X:1	kHz		Y:1.68553 Vrms
Entry Label			Hz		Vrms
Fundamental	1		k		1.686
2nd	2		k		22.742 m
3rd	3		k		1.221 m
4th	4		k		84.476 u
5th	5		k		19.106 u
6th	6		k		59.731 u
7th	7		k		34.871 u
8th	8		k		52.586 u
9th	9		k		25.253 u
10th	10		k		30.643 u

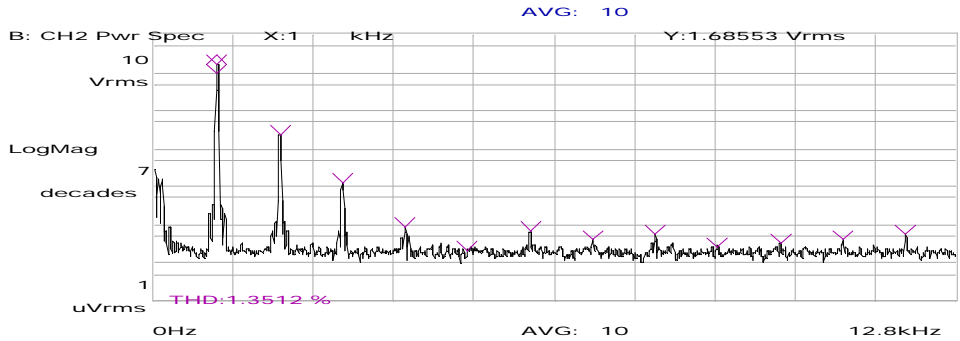

Fig. 2-8 1.5W Type 45 Triode feedback-less single-ended amplifier at 0.32 W rms.

A: CH2 Pwr Spec		X:1	kHz		Y:2.48566 Vrms
Entry Label			Hz		Vrms
Fundamental	1		k		2.486
2nd	2		k		25.926 m
3rd	3		k		7.872 m
4th	4		k		1.972 m
5th	5		k		397.03 u
6th	6		k		1.467 m
7th	7		k		426.504 u
8th	8		k		819.455 u
9th	9		k		230.985 u
10th	10		k		629.134 u

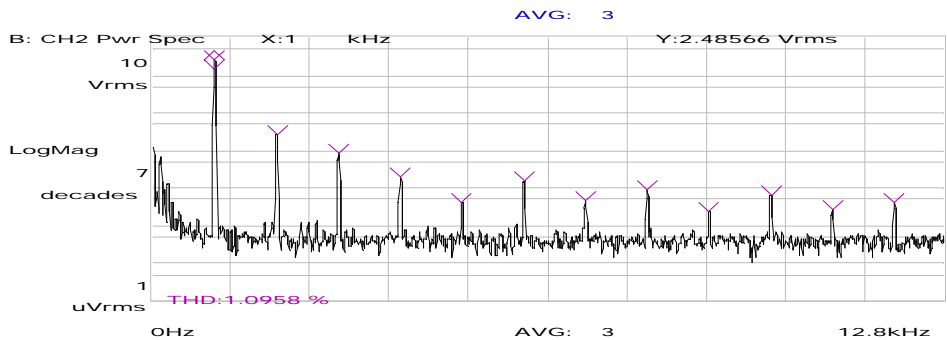

Fig. 2-9 10W Bi-polar transistor feedback amplifier at 0.72 W rms.

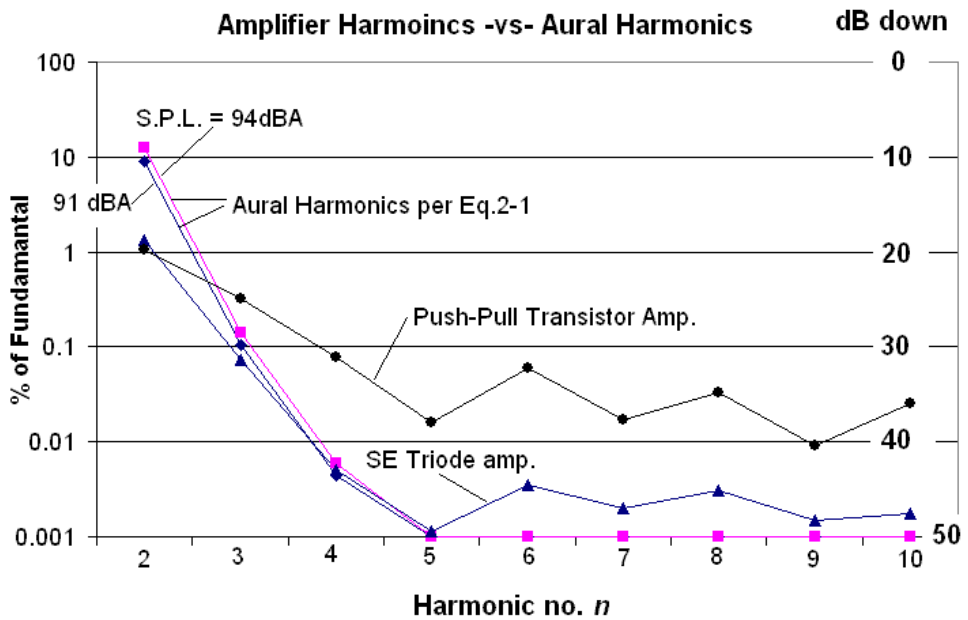

Fig 2-10. Two amplifiers distortion harmonics versus aural harmonics

	Harmonic number										
	dBa	2	3	4	5	6	7	8	9	10	
% aural harmonics	91	9.023	0.104	0.004	0.001	0.001	0.001	0.001	0.001	0.001	
amp Fig 2-8 (Triode SE)	94	12.352	0.143	0.006	0.001	0.001	0.001	0.001	0.001	0.001	
amp Fig 2-9 (BJT PP)		1.042	0.317	0.077	0.016	0.059	0.017	0.033	0.009	0.025	T.A.D.
amp Fig 2-8 %dev.		-85.079	-30.578	13.080	12.693	249.941	101.661	208.422	48.280	77.936	364.9051
amp Fig 2-9 %dev.		-91.565	121.690	1180.557	1496.943	5813.113	1613.596	3194.449	825.181	2430.169	7539.554

Table 2-1. Spreadsheet based T.A.D calculations for two amplifiers.

any grainy “electronic” sounds. The triode amps reproduction seemed to come from an absolutely quiet background and dynamics seemed improved, irregardless for the higher static signal to noise level and lower output power. The amplifiers superiority was well audible with most music. Most remarkable was the perceived instrument placement using

an all analog signal chain²⁷. Note that the standard T.H.D. measurement, performed by the D.S.A. to the 20th harmonic was 1.35% for the triode amplifier and 1.09% for the transistor amplifier. The T.A.D. figure is much worse for the transistor amplifier, a result of its high levels of high-order harmonic distortion.

2. Automated calculation of T.A.D.

Alternatively Eq. 2-1 calculates the individual harmonic levels in an automated T.A.D. test system, built on a PC computer using a high-quality sound card and an automated test software package like LabView. Ideally executed, a microphone could pick up the systems' loudspeaker output for direct reading of the fundamentals S.P.L. The entire music reproduction system could be rated in terms of T.A.D. In this case, the amplifiers distortion onset could be "tweaked" to minimize T.A.D. by changing loudspeaker efficiency or loudspeaker proximity. A very low value of T.A.D would guarantee that the reproduction systems sense of scale is realistic²⁸.

²⁷ Although outside of the scope of this research, the T.A.D. figure could include all elements of the signal reproduction chain, including the storage technology. Perhaps the decimation required by digital recording and playback alter the harmonic envelope. There is a controversial phenomenon where a LP record based playback system seems to have greater resolution than the digital system in the face of 100 fold higher signal to noise ratio. The most reasonable explanation may be that the current digital medium has higher levels of signal correlated noise.

²⁸ The change in slope of the aural harmonic envelope with intensity changes is well matched by feed-back free triode amplifiers, who, are universally low powered. This "scale matching" may explain the non-intuitive effect of increased dynamics with these type of amplifiers over amplifiers of much higher power ratings.

3 . Intermodulation distortion

Universally accepted work has shown a fixed correlation between an audio amplifiers static Intermodulation Distortion and its Harmonic Distortion characteristic ^{[14][15]}, including full mathematical derivations ^[15]. Alternatively, the ear generates intermodulation products due to the same non-linearity that causes Aural Harmonics to appear^[36]. Therefore the same T.A.D. figure of merit quantifies the audio reproductions devices' audible IM distortion. T.I.M. or D.I.M (Transient I.M. or Dynamic I.M.) per M. Otalas' extensive literature ^{[20][21][22]} has been shown to arise solely in feedback amplifiers due to input or intermediate stage slew-rate induced phase errors. In my extensive tests of zero feedback power amplifiers with even cascaded gain stages I was unable to measure increased I.M. due to dynamic affects using the described methodology. Indeed the 10W transistor amplifier showed the presence of D.I.M. Note the absence of intermediate I.M. lines in the zero-feedback amplifier. Dynamic Signal Analyzer output is presented in the following Fig's 2-11 & 2-12. The upper trace in Fig. 2-11 are the test harmonics per M. Otalas' "A Method for Measuring T.I.M.", a 3.14KHz Square wave lowpass filtered at 30kHz summed with a 15kHz sine of ¼ the square waves level. The lower trace of Fig 2-11 is the output of the type 45 triode amp, and Fig 2-12 the 10W transistor amp. Importantly, the multiplicative nature of feedback in creating many IM products actually

raises the noise floor by almost a factor of 10 when the test signal is injected. With no input the noise floor of the transistor amp was below the triode amp. These minor

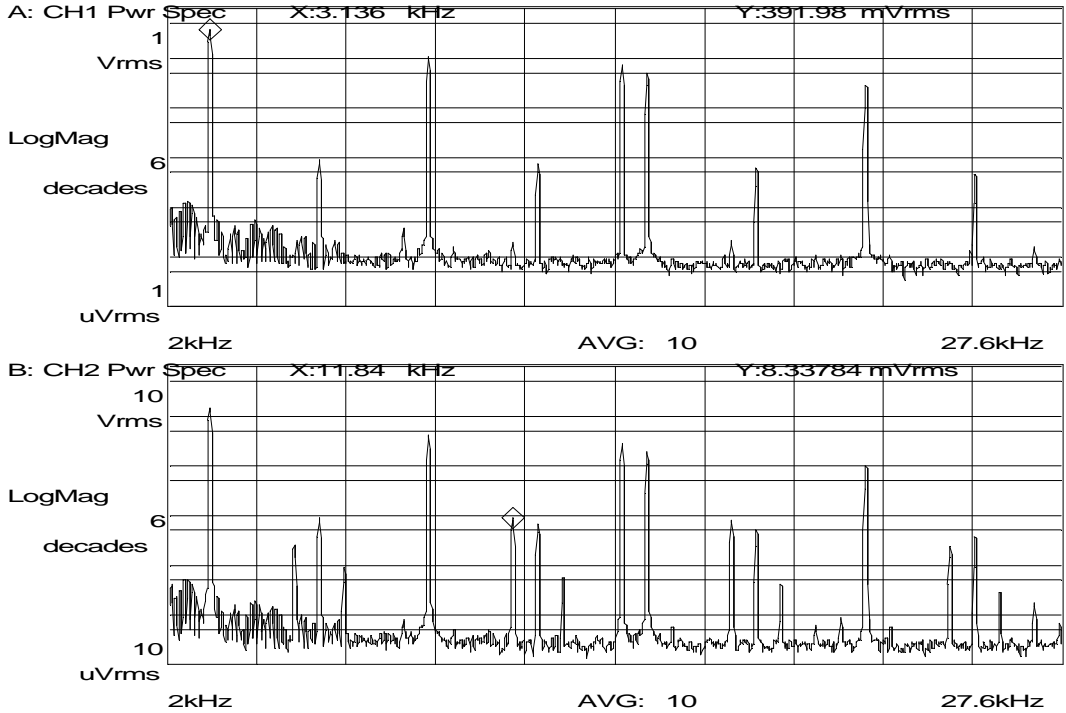

Fig. 2-11. *D.I.M. measurement example for a non-feedback amplifier*

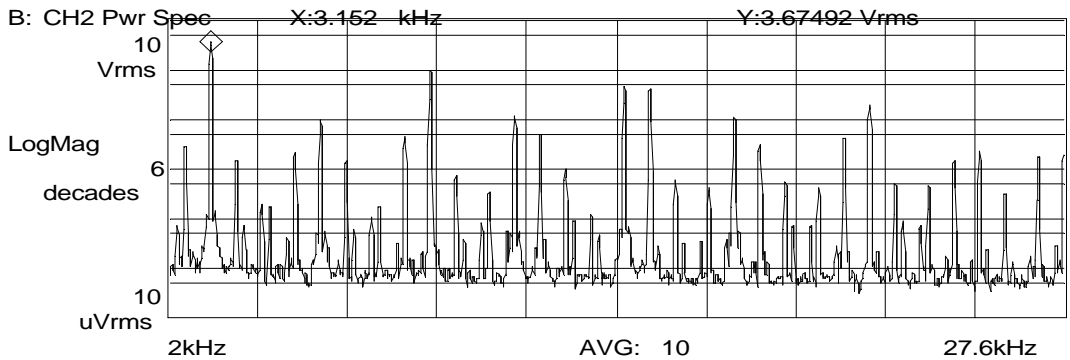

Fig. 2-12. *D.I.M. measurement example for a feedback amplifier*

sub-harmonics modulate in their relative relation to each other with signal level and could very well be responsible for the “grainy” sound associated with some high feedback audio amplifiers. The D.I.M. method picks out the specific harmonics peak amplitudes to calculate D.I.M. but does not specifically measure the noise floor for further IM harmonics and sub-harmonics.

4. Pre-transient Noise Bursts.

The noise burst detected during the first few 10ths of a second in a complex percussive sound like a piano or harpsichord has been shown to be a key element in the recognition process ^[37 pp. 153]. The brain has a very complex multi-tone intelligibility engine, but at a certain threshold the additional random vibrations (noise) the neural processing mechanism simply gives up. I propose that feedback in and of itself creates levels of intermodulation distortion that modulate and otherwise confuse the noise bursts of musical instruments, leading to a subjective response that the sound is “artificial”. An example would be the inability of even the finest instrumentation being able to quantify the difference between a Stradivarius violin and a more modest instrument ^[37 pp. 111]. Indeed the string player has the ability to introduce extremely fine changes in timbre. Our brain has learned to build up the corresponding identifying readout patterns based on tremendously refined information processing. We are able to recognize minute, unmeasurable, fine structures of the acoustical signal. If these fine structures are unmeasurable in the live acoustical field via a direct feed into the analyzing instrument it

follows that we are unable to determine if electronics are transparent in this regard! Indeed there exists currently no methodology that specifically analyzes the fidelity of a noise burst buried in a tone transient.

5. The fallacy of negative feedback as a cure-all.

This section details the common but incorrect assumption that negative feedback reduces non-linearity distortion in the same ratio as it reduces gain. This assumption is ~~true only if~~ there is no non-linearity to reduce. To avoid confusion with other work on feedback analysis I assign the following most common terms, K_v is the open loop transfer function of the gain block under analysis, and β is the transfer function of the feedback network, shown in the feedback block diagram Fig 2-13. In most modern

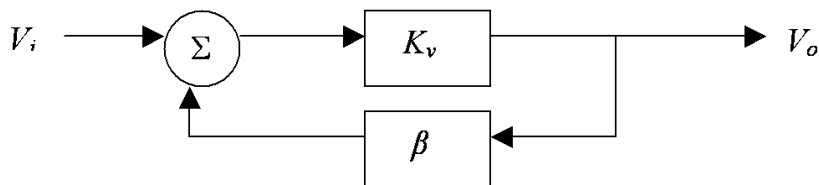

Fig. 2-13. *Negative feedback block diagram*

texts, these transfer functions are usually functions of frequency only. For example nearly all op-amp analysis concentrates on stability margin using root-locus methods to predict stability. Here we are concerned with the forward gain elements K_v non-linearity and assume that stability is present and operation is well within the pass-band. Indeed,

surprisingly, even phase shift is not involved in the analysis. Fig.2-13 is reduced to the familiar closed loop transfer functions in Eq. 2-3.

$$\frac{V_o}{V_i} = \frac{K_v}{1 - \mathbf{b}K_v} = \frac{1}{\frac{1}{K_v} - \mathbf{b}} \quad \text{Eq. 2-3.}$$

This result allows us to further define the following important terms used in analyzing and describing negative feedback systems.

Forward Loop Gain	= K_v
Loop gain	= $\beta K_v = A_l$
dB of feedback	= $-20\log (1 - A_l) $

Two results of the application of negative feedback not related to the forward loop linearity are bandwidth extension and output resistance reduction (Eq. 2-4). Their derivation is straight forward and included in standard analog electronic circuits text ^[38].

$$Z_c = \frac{Z_o}{1 - A_l} \quad \text{Eq. 2-4.}$$

Where, Z_c = closed loop output resistance, Z_o = open loop output resistance, A_l = loop gain.

In the case of bandwidth extension, commonly this applies to gain stages that are rolled off early by design to guarantee stability over a wide family of closed loop gains. In these cases negative feedback is necessary to achieve adequate frequency response. Op-amps,

power op-amps and single chip audio power amplifiers fall under this classification²⁹. Their output stages are universally push-pull in strict class B as they do not use complementary output devices and thus preclude some class AB bias scheme^[38]. Open loop these devices commonly are unstable due to their very high gain, and are far from hi-fidelity.

A mathematical proof follows that convincingly illustrates that even minimal amounts of negative feedback covert moderate amounts of low-order harmonic and intermodulation distortion into a multitude of high-order distortion products. I consider two classes of non-linearity, first, a parabolic transfer function that is closest to the F.E.T and AF transmitter vacuum tubes, and secondly an exponential transfer function that is very close to the ordinary junction transistor.

Consider an output gain device that departs from linearity only because of the presence of a square law term in the transfer function, as shown below in Fig. 2-14. Note how well this transfer characteristic follows a real device, a large N channel MOSFET³⁰. The X axis in Fig.2-14 is the voltage on the FET gate, V_{gs} . This region represents approximately 10% of the full current capability of the device, about 2 A.C. watts. Also, for convenience the output is offset to start at zero, although significant current is flowing throughout the shown range. With no feedback the transfer function

²⁹ The National Semiconductor LM3886 for example. A 60W rms monolithic chip that retails for under \$3. The open loop frequency response is shown falling off before 100Hz^[39]

³⁰ 55Amp I_d , 200V_{brdss}. Motorola MTY55N20

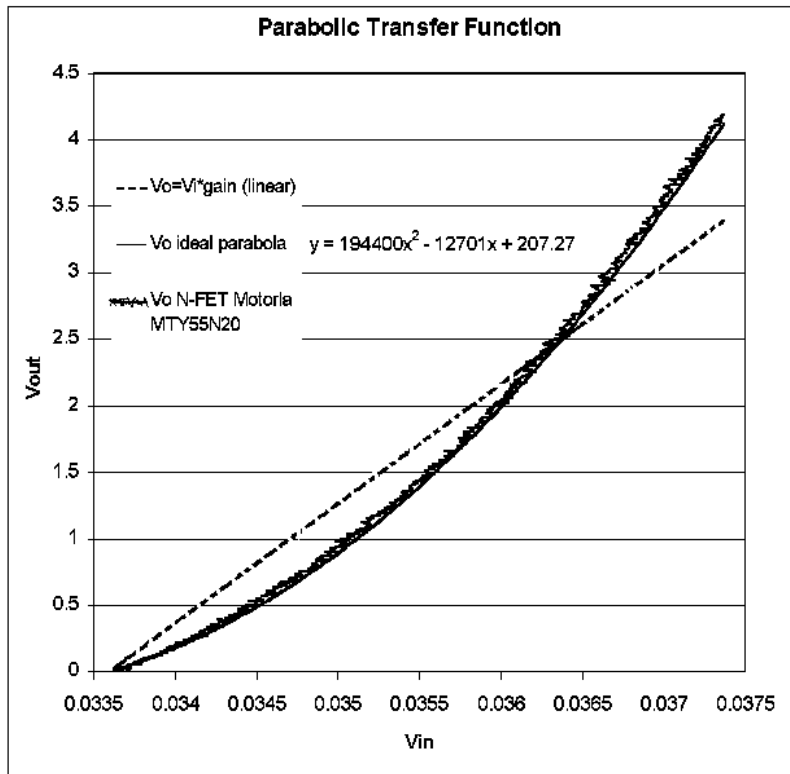

Fig. 2-14. Transconductance graph for a power field effect transistor.

can be written as:

$$v_{out} = Av_{in} + a(Av_{in})^2 \quad \text{Eq. 2-5}$$

Adding feedback to a system necessitates separating the input from the portion after the summing node, the portion that includes the negative feedback.

$$v_s = bv_{out} + v_{in} \quad \text{Eq. 2-6}$$

Clearly if β is increased the resultant transfer characteristic becomes more linear and at limit the gain is given by:

$$\frac{v_{out}}{v_{in}} = \frac{-1}{\mathbf{b}} \quad \text{Eq. 2-7}$$

Adding feedback to a non-linear gain element creates modulation at the sum and difference frequencies. In the case of the purely square term function, a single sine input of frequency f creates only second harmonic distortion. As soon as some feedback is applied a third harmonic appears, which is again fed back and creates sum products at $f+3f$, or fourth harmonic, and $2f+3f$, fifth harmonic. This previous discussion is intuitive but can also be shown mathematically. To arrive at this one uses a power series to define the closed loop (feedback included) transfer characteristic of the type:

$$v_{out} = a_1 v_{in} + a_2 v_{in}^2 + a_3 v_{in}^3 + a_4 v_{in}^4 + \dots \quad \text{Eq. 2-8.}$$

To obtain the corresponding closed loop power series the feedback equation Eq. 2-6 is substituted into the square term transfer characteristic Eq. 2-5. This produces a quadratic equation relating v_{in} and v_{out} . To transform this into a power series the binomial theorem is used. The resultant harmonic weights as a function of v_{out} are shown in Table 2-2.

Harmonic Number	Percentage of fundamental
2	$\frac{50 \mathbf{a} V_{out}}{1 - A \mathbf{b}}$
3	$\frac{50 A \mathbf{b} \mathbf{a}^2 V_{out}^2}{(1 - A \mathbf{b})^2}$
4	$\frac{62.5 A^2 \mathbf{b}^2 \mathbf{a}^3 V_{out}^3}{(1 - A \mathbf{b})^3}$

5	$\frac{87.5 A^3b^3 a^4V_{out}^4}{(1-Ab)^4}$
6	$\frac{131.25A^4b^4a^5V_{out}^5}{(1-Ab)^5}$

Table 2-2. *Distortion components versus feedback level for a square law dominated gain device*

Note the strong function of output level V_{out} of the higher harmonics. What is more subtly hidden is the sharp increase of higher harmonics as even moderate feedback is applied. Figure 2-13 following reveals this behavior over a broad range of feedback. Fig. 2-15 is realized by fixing V_{out} to ~2 Watts AC and plotting Table 2-1's percentage of fundamental per harmonic number versus the feedback factor, β . a in the Fig. 2-15 is designated in the somewhat more common k . In Chapter 3 actual device measurements results of F.E.T's and B.J.T.'s are included and show good agreement with the calculations in this section although slight de-generation of the FET gate drive results in some H3 and higher distortion with no feedback in place. The levels were at least a factor of 10 below the sum-difference based feedback modulation "maximas" shown. This data, when plotted along with the corresponding T.A.D. "Total Aural Disconsonance" figure of merit, conclusions about proper level of negative feedback are readily drawn.

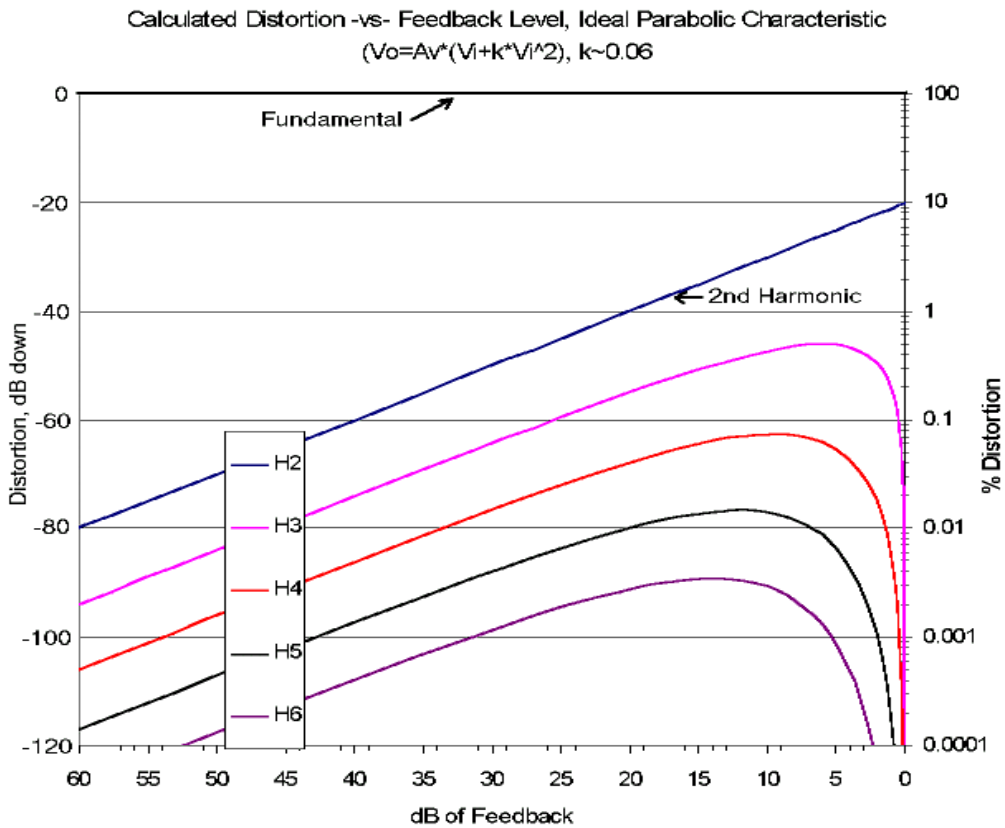

Fig 2-15. Calculated Distortion versus feedback level using the equations in Table 2-2.

In Fig 2-15 above note the sharp rise in the levels of distortion as only 3dB of negative feedback is applied! More importantly note the minor reduction in the aurally benign 2nd harmonic versus the rise of the more dissonant harmonics. For the plotted curves in Fig. 2-15 $a = .06$, and the resulting zero-feedback 2nd harmonic distortion is 10%. This is higher than the ears aural harmonics, and thus higher than acceptable subjectively. The output devices a needs to be reduced and this effort is detailed in Chapter 3. Never the less the family of harmonics created by varying levels of feedback remain similar in

relationship to each other with different levels of device square term non-linearity. With this ideal 2nd order parabolic transfer characteristic two fundamental issues arise.

1. A large amount of feedback is necessary to reduce the distortion of harmonics H3 and higher their level before the application of feedback.
2. Very high harmonics will not be reduced by practical levels of feedback, since the “knee” and the slope of rising harmonic power clearly moves towards higher feedback. At some point, no matter what device or topology, feedback cannot be raised any more or instability will result due to unavoidable phase shifts, slew limitations, and frequency extension bounds.

To claim that these distortions are in-audible is fallacious, as they modulate at higher and higher non-linear degrees with the instantaneous signal level. The math shows that negative feedback creates a complex signal modulated high frequency “hash” on the signal. Arguably these calculations calls into question the entire practice of negative feedback. Additionally it seems to explain the “re-birth” of zero feedback versus low levels of feedback by the newest reference designs. I emphasize that the subjective capabilities of audio amplification are far more strongly aligned with open-loop linearity than magnificent closed loop single-sine bench test results. Why else would state-of-the-art audio amplification designers move towards lower feedback, when advancements in output device bandwidth allow the application of greater levels of feedback?

Now we consider the transfer function of the junction transistor, the most popular small signal and power output gain device. A junction transistor follows very accurately an exponential transfer function of the type:

$$I_c = I_o \exp \frac{qV_{be}}{kT} \quad \text{Eq. 2-9.}$$

Where I_c = collector current, I_o = constant related to h_{fe} , V_{be} = base-to-emitter voltage, q = electron charge 1.60×10^{-19} coulombs, k = Boltzmann's constant 1.38×10^{-23} joules/°C, T = absolute temperature in °C.

Analysis of the effects of application of negative feedback are as before. The closed loop transfer function is:

$$v_{out} = -R_f I_{dc} \left[\exp \frac{qV_{in}}{kT} * \exp \frac{q\beta v_{out}}{kT} - 1 \right] \quad \text{Eq. 2-10.}$$

β = feedback factor.

In order to calculate the harmonics in v_{out} when $v_{in} = V_{in} \sin \omega t$ again the equation must be expressed as a power series.

$$v_{out} = a_1 v_{in} + a_2 v_{in}^2 + a_3 v_{in}^3 + a_4 v_{in}^4 + \dots \quad \text{Eq. 2-8.}$$

The values of the coefficients a_1, a_2, a_3 , etc. are found using Maclaurin's theorem.

$$a_1 = \left. \frac{dv_{out}}{dv_{in}} \right|_{v_{in}=0}$$

$$a_2 = \frac{1}{2!} \left. \frac{d^2 v_{out}}{dv_{in}^2} \right|_{v_{in}=0}$$

$$a_3 = \frac{1}{3!} \left| \frac{d^3 v_{out}}{dv_{in}^3} \right|_{v_{in}=0} \quad \text{Eqn's 2-11}$$

Successively differentiating the closed loop transfer function (Eq. 2-10) the harmonic coefficients are as follows in Table 2-2.

a_1	$\frac{A}{1 - A\mathbf{b}}$
a_2	$\frac{1}{2!} \frac{q}{kT} \frac{A}{(1 - A\mathbf{b})^3}$
a_3	$\frac{1}{3!} \left(\frac{q}{kT} \right)^2 A \left[\frac{1}{1 - A\mathbf{b}} - \frac{3 A\mathbf{b} }{(1 - A\mathbf{b})^2} + \frac{3 A\mathbf{b} ^2}{(1 - A\mathbf{b})^3} - \frac{ A\mathbf{b} ^3 + 3 A\mathbf{b} }{(1 - A\mathbf{b})^4} + \frac{3 A\mathbf{b} ^2}{(1 - A\mathbf{b})^5} \right]$

Table 2-3. *Distortion components versus feedback level for an exponentially non-linear gain device.*

In these coefficients, $A = -g_m R_l$ where g_m is the transistor mutual conductance when $v_i = v_{out} = 0$ and the collector current is biased to I_{dc} . As before, I present a graph of the calculated harmonics as a percentage of fundamental versus the feedback factor β . Inspection of Fig. 2.16 reveals that unlike the parabolic transfer function of the vacuum tube or F.E.T the junction transistor creates higher order harmonics without feedback applied. In view of the complexity of the a_3 term and specifically the + and – signs attributed to terms of differing power one has to assume that higher orders than H3 will

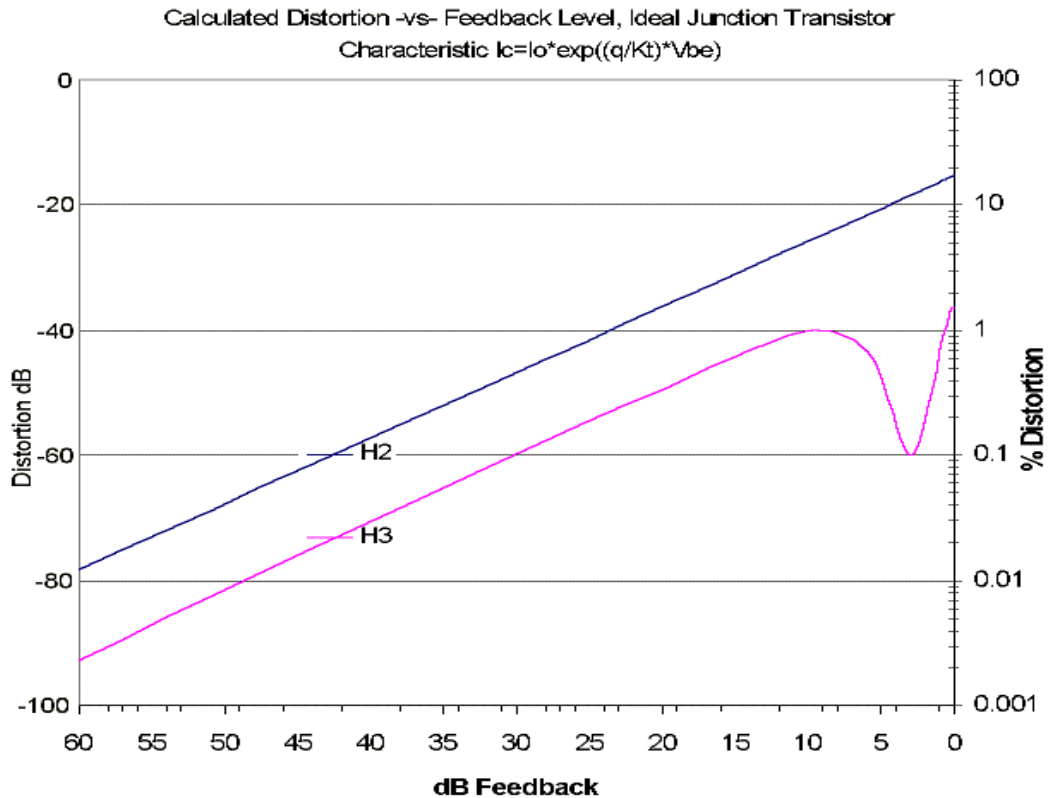

Fig. 2-16. Calculated Distortion versus feedback level using the equations in Table 2-3.

contain a family of “bumps” with their maximas at differing levels of β . The non-similar rates of harmonic generation exaggerated by the application of feedback clearly do not conform to the ears self distortion and are therefore not masked. In attempting to maximize the T.A.D. (Total Aural Disconsonance) figure of merit for a junction transistor based output stage, over a range of operating levels, it again seems that the zero-feedback approach may be chosen. This is examined in more detail in Chapter 3.

Another intrinsic effect of the application of negative feedback is gain reduction of the stage. In order to have serviceable output from an audio amplifier with

50dB of negative feedback, driver stage gain must be $\times 1000$ to “make up” the lost gain. In these calculations we concentrate on output stage devices that, in the case of the FET or vacuum tube haven inherently higher non-linearity than the similar class small signal device. The BJT seems to exhibit similar exponential transfer regardless of junction substrate size. But these devices still have very real non-linearity. In common modern practice negative feedback is applied in local loops. In order to get any appreciable gain from a driver or pre-amp single transistor stage a limited amount of feedback can be applied. For example, a BJT may have single-ended gain of 500x. To produce 50x gain, only 20dB of local feedback is possible. This driver stage now runs into the same problems of harmonic multiplication and departure from any semblance to the ears self distortion. To conclude the section I again state that feedback amplifier testing towards a goal of correlation with subjective transparency needs to be radically transformed. We must move from single-sine THD of the closed loop amplifier to T.A.D. figures of the output and driver stages with feedback removed. This is possible and the methodology is discussed at the end of Chapter 3.

CHAPTER III

MEASUREMENT PROTOCOL OF THE TOTAL AURAL DISCONSONANCE FIGURE OF MERIT

1. Device measurements.

In the previous chapter it was shown the excellent fit of the transfer function of the MOSFET and a parabola. In this chapter an actual device is configured as a Single-ended (not push-pull) output stage with an adjustable feedback control as shown in Fig. 3-1³¹. This circuit was truly single stage as no other active elements are connected. This

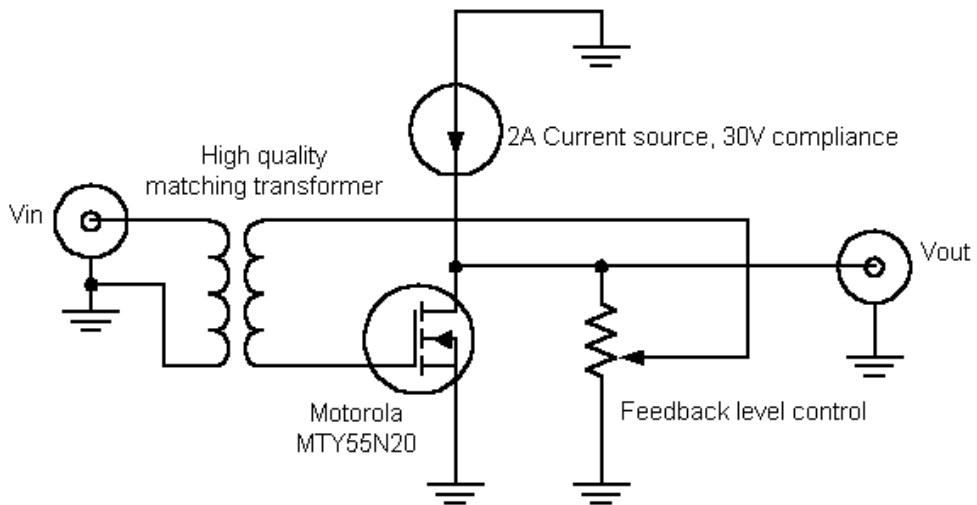

Fig. 3-1. Schematic of the single - ended F.E.T. output stage.

simplicity is afforded by the use of a UTC hi-fi matching transformer. By connecting the return side of the secondary to the feedback control potentiometer one can adjust feed-

³¹ Not shown here is a summing node at the transformer secondary that used a DC voltage source to shift the bias up into the linear region of the FET. The bias voltage is approximately 3.6V.

back to zero (with the input signal now presented to the FET gate to source unchanged) or near infinite, with the entire transconductance of the FET being subtracted from the input. The instrument again used is the HP 35670A. The internal signal source produced no measurable distortion at the secondary over the signal level range required to fix the output of the circuit in Fig. 3-1 to a constant value with a feedback range of 0 to 50dB. 1kHz was chosen as the frequency, and 2W AC was the fixed output power. The MOSFET chosen is a 55A I_d , 200V_{ds} Motorola TY55N20. This was mounted on a large heatsink, as the operating point found to be most linear was with a quiescent bias point of 1.0A or greater. No measurements were done at operating points higher than 2A as this was the limit of the high-speed current supply. This can be overcome by configuring a second similar fet as a current source, but this device could/will then add harmonics of its own. The current source was tested to 20kHz and contained un-measurable harmonic distortion when sourcing 1A +/- 0.25A. The test results are plotted in Fig. 3-2, next page, along with the calculated results from Chapter 2, section 5. The circles represent measured data points. The difference between the measured and calculated values is explained as follows. The measurable appearance of H3 and higher at the zero-feedback point means that over this operating range the transfer function is not purely a polynomial of the second order. Some cubic or higher order terms must be present. This also must account for the difference between the two data sets at point with feedback applied. Another factor is the a used in the calculations may not actually match, and results in the

slight difference of the second harmonic. On interpreting the results for possible masking by the ears aural harmonics the data gets interesting. Note in Fig. 3-2 the additional horizontal lines marked "Aural Harmonic". These represent the ear self distortion at 98dB system S.P.L. Why plot 98dB? Because it is clear from the aural harmonic envelope that the fall off matches most closely the zero-feedback data!

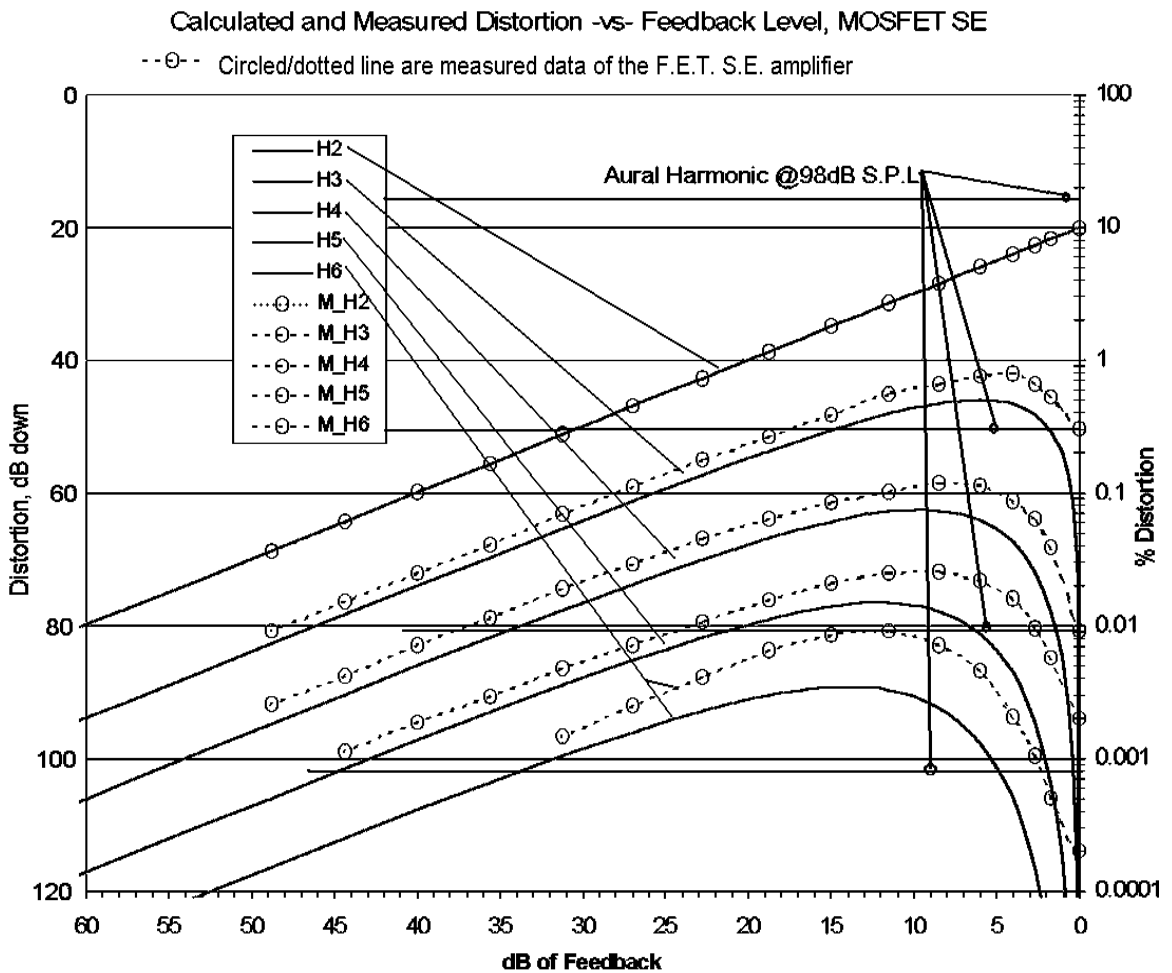

Fig. 3-2. Calculated and Measured Distortion versus feedback level, FET SE output stage.

SPL dBa	Harmonic				
	2	3	4	5	6
96	15.23	0.176	0.00744	0.00064	0.00009
97	16.91	0.195	0.00826	0.00071	0.00010
98	18.77	0.217	0.00917	0.00079	0.00011
99	20.85	0.241	0.01018	0.00087	0.00012
100	23.15	0.268	0.01130	0.00097	0.00013

Table 3-1. *Aural Harmonics from Eq. 2-1 over a reduced S.P.L range.*

Table 3-1 is summarizes a range from 96 to 100dB SPL. The obvious interpretation is that if feedback is believed to be required to reduce the subjectively benign 2nd harmonic, even the slightest application pushes the harmonics together to an extent that aural masking can never be complete. Or, on the other hand, if a large amount feedback is instituted to reduce the harmonics to the levels without feedback, no single feedback factor “fits” the aural harmonic envelope, and certainly, the H2 component will be so reduced that masking is not in affect anyway. One may argue that I “made the data fit” via plugging in a very high SPL. This is invalid, as the amplifier is sourcing the equivalent of 2W, and, a 92 dB/W loudspeaker is commonplace, and a pair would, at 1 meter, create 98 dB S.P.L³².

A study, not as thorough as the FET SE gain stage, was done with two different vacuum tubes. Both the type 19 and the type 45 showed a transfer characteristic that was at least 5 times more linear than the FET over a much wider relative output range (the a term was >5 times smaller). The type 19 is limited to 2/10W, and although

³² Most installation are two channel (stereo). 2W is 3dB louder than 1W, and two loudspeakers almost double the S.P.L. 98-3-3 = 92dB

very promising musically, its dynamic range is audibly limited with normal efficiency loudspeakers, to the extent that the reproduction seemed artificial because the level was not as one experiences “live”. The type 45 with ~2.5W is indeed able to reach “jazz club” signal levels with a 96dB/W loudspeaker system³³. The harmonic content of a type 45 output stage was previously analyzed in Chapter 2 section 2, and plotted in Fig. 2-10. In this amplifiers case, conformance to the aural harmonic envelope remained nearly exact to 0.001% of fundamental.

2. A Measurement protocol for the Total Aural Dissonance figure of merit

In review, global or single stage negative feedback is not required for audio amplification if a single-ended design is chosen. The design will contain harmonics at much higher levels than the same device used in a feedback amplifier, but, the harmonics may match the ears self-generated envelope of harmonics, and result in a better TAD figure. In general only two gain stages will be required, in contrast to at least five with modest feedback level amplifiers. TAD analysis is required on the whole amplifier, including the driver / voltage gain stages. Commonly, there is very little power gain required, and thus these stages are always more linear as the operating range is a smaller portion of the devices total range. As discussed in Chapter 2 section 5, for TAD analysis

³³ There exist larger triodes with similar symmetrical geometry to the type 45. For example the type 50 is capable of greater than 6W but has reached such a cult status that prices can reach over \$500 for individual tubes at half-life discarded in the 30’s.

of feedback amplifiers, the feedback loop must be removed. In general the amplifier will be unusable and probably stable as the gain is now increased by the feedback ratio, usually 30dB or 1000 times.

In attempting testing of audio amplifiers with the feedback removed I discovered a procedure that guarantees stability yet allows for the removal of the feedback from the tested signal path. With the input left open, a low output impedance signal is injected directly into the feedback path before the phase compensation network. The output of the amplifier is now without the benefit of loop feedback and all the following gain stages and the output stages are in a sense open loop. Fig. 3-3 shows the

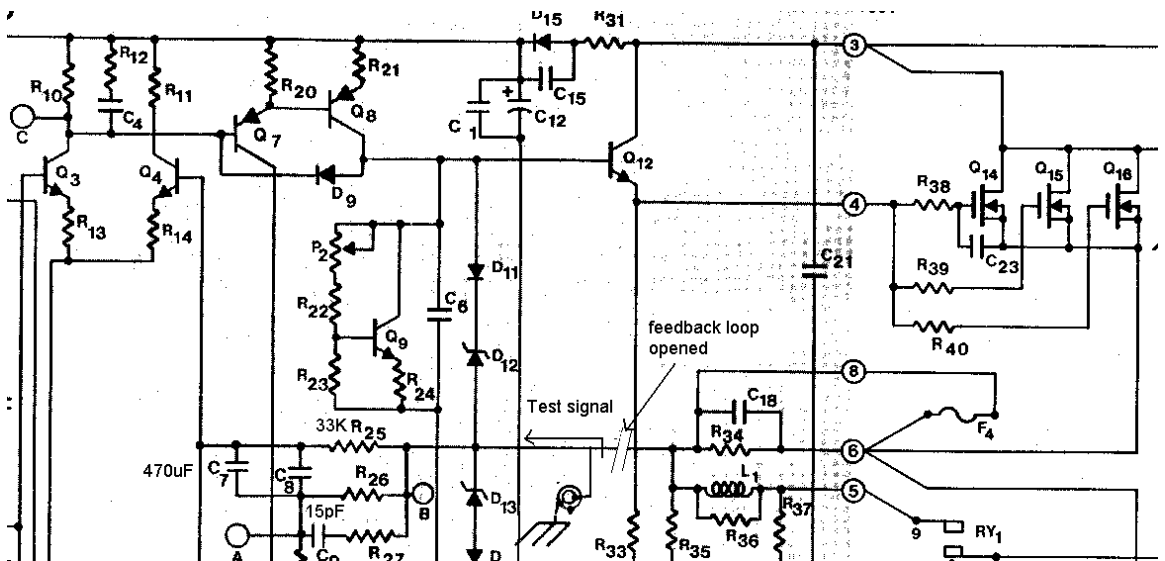

Fig. 3.3. Subset of the DH500 amplifier schematic showing the point where feedback is removed and a signal injected.

signal injection point for the DH500. Note the test signal source must be low output impedance and be connected before the opening of the loop. This test signal runs through the entire amplifier- Q3-Q7 diff. Amp, Q7-Q8 gain, and Q12 gate driver. The open loop performance can now be tested with the same instrumentation. Harmonic distortion now dominates. At 0.4W out (similar output power as the type 45 amplifier shown in Fig. 1-16) the DH500 exhibited 23.6% THD, shown in the following Fig.3-4. Note the strong odd-order components. These are not due to classic push-pull cross-over distortion, as the DH500 bias circuit is connected and performing as designed, but must be due several transistors in the forward path, but most likely the output FETs, swinging

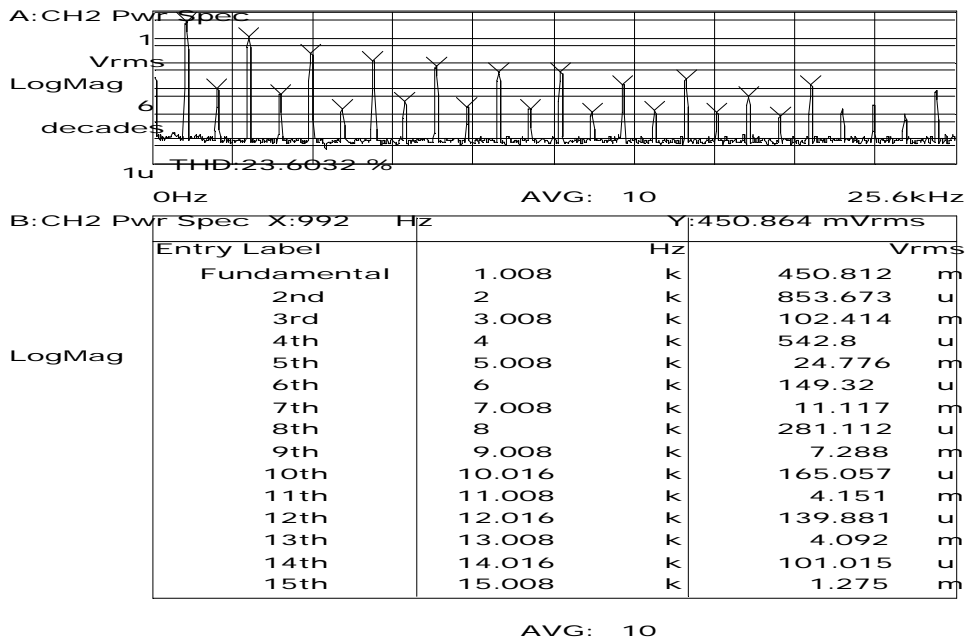

Fig. 3-4. DH500 Open-loop harmonic distortion at 0.4W

into a non-linear area. These harmonics needless to say do not follow the aural harmonic envelope. Calculation of the TAD is not necessary. The claim is that this poor open-loop performance is why the amplifier did not sound as natural or dynamic as the type 45 tube amplifier.

CONCLUSION

The research I undertook to determine a better audio amplifier measurement methodology has resulted in a concept and method that better correlates an objective figure of merit to the subjective experience than previous protocols. Rudimentary exploration with a varied listening panel of five people using directly fed real-time signals from a piano showed that the T.A.D. number rated a set of 3 amplifiers correctly while the standard accepted T.H.D. and I.M. results did not. It is my belief that the TAD figure of merit specification, in general, applied to a broader set of electronic devices, enables objective measurements to better rate sound reproduction equipment sound quality. Those who have the intent to consider further research in this area could concentrate on the following areas:

- T.A.D. system effects. Even the very well designed loudspeaker is the highest distorting device in the audio chain. The harmonics fall off sharply with rising order on the other hand. Perhaps the system T.A.D. actually correlates better with the natural harmonic envelope of the ear with the addition of the $>5\%$ 2nd harmonic distortion of the loudspeaker.
- T.A.D. of the storage and retrieval system. Perhaps lowering the T.A.D. rating of digital electronics by concentration on bit depth rather than raising the channel

density (surround sound) or the sampling rate can result in real gains in transparency.

- Sex and age effects on an individuals aural harmonic envelope. Similar studies to the Fletcher and Olson aural harmonics work can be carried out to determine any major changes in the harmonic envelope.

The limitations of the research documented herein are similar to the previous statements. The aural harmonic envelope needs to be proven reasonably similar across age, sex, and other factors in order for the T.A.D. mathematical derivation to be accurate. The entire sound reproduction system is required to follow the harmonic envelope. It is my belief that the audio power amplifier is the largest detractor from the envelope, but this needs to be proven.

The public has limited access to participate in demonstrations of single-ended audio amplifiers. Very few mainstream Hi-Fi shops have this type of equipment set-up. I know of none in the Boston area. If the reason for this is the need for suppliers and salespeople to stick to what they know- mainly the specifications race then the specifications need to change. These amplifiers are clearly superior in many of the most important areas of sound reproduction. Unfortunately the design has some drawbacks.

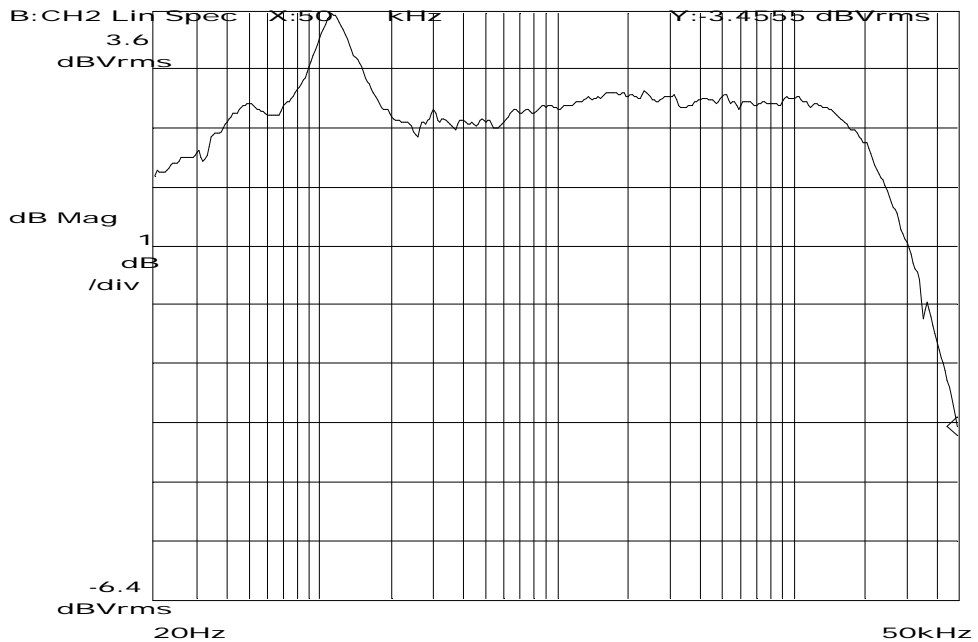

Fig. 3-5. *Output level variation of the type 45 SE amplifier when loaded with a loudspeaker*

The output impedance of these amplifiers is in the ohms range, hundreds of times worse than solid-state push-pull amplifiers. This requires careful mating with loudspeakers that do not have great impedance variation with frequency. For example, a set of 1960's Radio Shack 16 ohm PA monitors was necessarily chosen in the listening tests because it had a very little impedance variation over the range of frequencies used in the listening tests- a grand piano. As shown in Fig 3-5, this speaker was flat within $\pm 0.25\text{dB}$ from 180Hz to 18kHz, meeting the ABX^[40] specifications for frequency response matching. Loudspeaker efficiency is also an issue with amplifiers with power outputs of less than 5W. This is being addressed and there are dozens of loudspeakers on the market with

efficiencies greater than 95dB/W/m. The pluses far outweigh the minuses and I am convinced that zero-feedback single-ended designs will continue to become more widespread. I plan on pursuing this methodology, and am in the process of designing a PC based data-acquisition system that displays real time TAD figures, allowing for the fine tuning of bias points in audio amplifiers.

BIBLIOGRAPHY

- [1] Stereophile Magazine. Vol. 18 No. 9, September 1995 pp. 141-149
Stereophile, 208 Delgado, Santa Fe, NM 87501
- [2] Stereophile Magazine. Vol. 18 No. 9, September 1995 p.145
- [3] Stereophile Magazine. Vol. 18 No. 9, September 1995 p. 148
- [4] Stereophile Magazine. Vol. 18 No. 9, September 1995 pp. 147-148
- [5] Stereophile Magazine. Vol. 198 No. 10, October 1996 p.284
- [6] Kellogg, Edward. "The design of non-distorting power amplifiers"
- [7] W.T. Cocking 1934
- [8] Black, Harold S. "Stabilized Feedback Amplifiers"
BSTJ January 1934, pp. 1-18
- [9] Williamson, D.T.N., "Design for a High Quality Amplifier"
Wireless World, April 1947 (pt1) pp. 118-121;
May 1947(pt2), pp. 161-163.
- [10] McIntosh, Frank & Gow, Gordon. "Description and Analysis of a New 50-Watt Amplifier Circuit"
Audio Engineering, December 1949
- [11] Hafler, David & Keroes, Herbert. "An Ultra-Linear Amplifier"
Audio Engineering, June 1952
- [12] Radio Manufacturers Association (UK) 1937 "Specification for testing and expressing overall performance of radio broadcast receivers"
- [13] Callendar, M.V "Feedback" column
Electrical Engineering, October 1950 p. 443

- [14] Shorter, D.E.L. “The Influence of High Order Products in Non-Linear Distortion”
Electrical Engineering, April 1950 pp.152-153
- [15] Bloch, Alan “Measurement of Non Linear Distortion”
Journal of the Audio Engineering Society, January 1953 pp. 62-67
- [16] SMPTE I.M. Standard
“Society for Motion Picture and Television Engineers”
- [17] Crowhearst, Norman. “Some Defects in Amplifier Performance not covered by Standard Specifications”
Journal of the Audio Engineering Society, October 1957. pp. 195-201
- [18] Crowhearst, Norman. “Feedback – Head Cook and Bottle Washer”
Audio, April 1959
- [19] Listener Magazine, Vol 7, No.5 (9,10 2001) pp. 62. ISSN number 1529-9333
Englander Communications, LLC, 75 Holly Hill Lane, Greenwich, CT 06830
- [20] Ojala, Mati J. “Transient Distortion in Transistor Audio Power Amplifiers”
Journal of the Audio Engineering Society, 1970
- [21] Ojala, Mati J. “Circuit Design Modifications for Minimizing Transient Intermodulation Distortion in Transistor Audio Power Amplifiers”
Journal of the Audio Engineering Society, 1977
- [22] Ojala, Mati J. “A Method for Measuring T.I.M.”
Journal of the Audio Engineering Society, 1977
- [23] Ojala, Mati J. “Correlation Audio Distortion Measurements”
Journal of the Audio Engineering Society, Jan/Feb 1978, Vol. 26 No. 12
pp. 12-19
- [24] Cabot, Richard C. “Comparison of Nonlinear Distortion Measurement Methods”
Proceedings of the 11th International AES Conference 1992.
- [25] Pass, Nelson. Article “Single ended class A”
<http://www.passlabs.com/articles/seclassa.htm>

- [26] Stereophile Magazine. Vol. 21 No. 3, March 1998 p. 148
- [27] M. Liberman, "Cochlear Frequency Map for the Cat",
Acoust. Society of America. pp72-77, Nov. 1982.
- [28] Olsen, Harry F. "Music, Physics and Engineering"
Dover Publications, Inc. N.Y., 2nd ed. : 1967.
- [29] Newman, Edwin Broomell.. "Factors in the production of aural harmonics and combination tones" Lancaster, Pa., Lancaster Press, 1937.
Reprinted from The Journal of the Acoustical Society of America, Vol. 9, No. 2, October, 1937.
- [30] , [31] , [32]
Fletcher "Speech and Hearing", 1924.
D. Van Nostrand Company, Inc, and Bell Telephone Laboratories.
- [33] , [34]
Olson, Harry F. , Massa, Frank. F. "Applied Acoustics", 1934
Van Nostrand Co.
- [35] J. Goldstein, "Auditory Non-linearity", J. Acoustical Society of America. 41, pp. 676-689, 1967
- [36] Alternatively, the ear generates intermodulation products due to the same non-linearity that causes Aural Harmonics to appear
- [37] Roederer, Juan G. "Introduction to the Physics and Psychophysics of Music" 2nd Edition. 1979.
Heidelberg Science Library, Spring-Verlag, Berlin Germany
- [38] Northrop, Robert B. "Analog Electronic Circuits"
Addison-Wesley 1990
- [39] LM3886 data sheet. National Semiconductor Corporation
<http://www.national.com/datasheets/lm3886.pdf>

- [40] Clark, David L., "High-Resolution Subjective Testing Using a Double-Blind Comparator", *Journal of the Audio Engineering Society*, Vol. 30 No. 5, May 1982, pp. 330-338.